

Multifunction Automatic Supporting Equipment for Welding



BUH02B07

WEAVING UNIT

WU-3R

OPERATION MANUAL



For every person who will be engaged in operation and maintenance supervision, It is recommended to read through this manual before any operations, so as to permit optimum operation of this machine.

KOIKE SANZO KOGYO CO.,LTD.

INTRODUCTION

Thank you very much for purchasing this product. Read this instruction manual thoroughly to ensure correct, safe and effective use of the machine. Read the manual first to understand how to operate and maintain the machine. Cooperation between colleagues in the workplace is essential for safe, smooth operation.

Make sure you read, understand and take all the necessary safety precautions.









SAFETY PRECAUTIONS

This product is designed to be safe, but it can cause serious accidents if not operated correctly. Those who operate and repair this machine must read this manual thoroughly before operating, inspecting and maintaining the machine. Keep the manual near the machine so that anyone who operates the machine can refer to it if necessary.

- Do not use the machine carelessly without following the instructions in the manual.
- Do not use the machine until you have thoroughly understood the explanations in the manual.
- For safety, leave the installation, maintenance, inspection, and repair of the machine to a trained person who has thorough knowledge about welding machines or to a qualified operator.
- For safety, leave the operation of the machine to a person with complete knowledge of the instruction manual and sufficient skill.
- For safety education, make use of respective lecture meetings sponsored by the Welding Society and Welding Association, as well as by headquarters and branches of related scientific societies and associations. Make use of qualification tests for welding engineers and welding technicians as well.
- After reading the manual, keep it together with the warranty within reach of people concerned. Read the manual again as necessary.
- Contact our dealers or our branch office, sales office, or local office for any obscure points.
- When this manual is lost or damaged, place an order promptly with our dealer for another copy.
- When transferring the machine, be sure to attach the instruction manual to the machine to transfer it to the next owner.

QUALIFICATIONS FOR MACHINE OPERATOR

Operators and repair staff of this machine must completely understand the contents of the instruction manual and they must be qualified and educated to handle this equipment.

Symbol	Title	Meaning
	General	General caution, warning, and danger.
	Be careful not to get your fingers caught.	Possible injury to fingers if caught in the insertion part.
	Caution: Electric shock!	Possible electric shock under special conditions.
	Ground this equipment.	Operators must ground the equipment using the safety grounding terminal.
	Pull out the power plug from the outlet.	Operators must unplug the power plug from the outlet when a failure occurs or when there is a danger of lightning.
	Caution against bursting	Possible bursting under certain conditions.
	General	General warning.
	Caution: Hot!	Possible injury due to high temperature under certain conditions.
	Caution: Ignition!	Possible ignition under certain conditions.
	Caution: Magnet	Generating a magnetic field and magnetic waves.
	Wear light shielding goggles.	Be sure to wear light shielding goggle when looking at welding arcs.
	Wear dust/gas mask.	Wear a mask when dust, smoke, or gas is to be generated during work.
	Do not lift.	Lifting the carriage is prohibited to prevent an accident due to falling.



CONTENTS

1. Safety information-----	1
2. Safety precautions-----	2
3. Location of Safety labels-----	7
4. Features and specifications-----	8
4.1 Features-----	8
4.2 Configuration-----	8
4.3 Specifications-----	12
4.4 Name of each part-----	15
5. Preparation for operation-----	19
5.1 Torch stand mount kit-----	19
5.2 WEL-HANDY MULTI NEXT mount kit-----	21
5.3 TYPE-F WU-3R WEAVING HOLDER SET-----	23
6. Preparation and welding operation-----	30
6.1 Torch stand mount kit-----	30
6.2 WEL-HANDY MULTI NEXT mount kit-----	30
6.3 TYPE-F WU-3R WEAVING HOLDER SET-----	49
7. Operational precautions-----	49
8. Maintenance-----	50
8.1 Maintenance and inspection-----	50
8.2 Recommended spare parts-----	51
8.3 Trouble shooting-----	51
8.4 Warranty-----	52
9. Wiring diagram-----	53
9.1 WEAVING UNIT WU-3R-----	53
9.2 IK-12 NEXT-----	54
10. Assembly drawing-----	57
10.1 Torch stand mount kit-----	57
10.2 WEL-HANDY MULTI NEXT mount kit-----	58
10.3 TYPE-F WU-3R WEAVING HOLDER SET-----	59
11. Parts list-----	60
11.1 Weaving unit WU-3R-----	60
11.2 Torch stand mount kit-----	62
11.3 WEL-HANDY MULTI NEXT mount kit-----	64
11.4 TYPE-F WU-3R WEAVING HOLDER SET-----	66

1 Safety information

Most accidents are caused by negligence of basic safety regulations during operation, inspection, and maintenance. Carefully read, understand, and master the safety precautions and preventive measures written in this manual or on the machine before operation, inspection, and maintenance of the machine.

- Carefully read this manual before use.
- Conduct installation of motive power source on the primary side, select the location of installation, store high-pressure gas, install pipes, store products after welding, and dispose of waste in conformity with laws and your in-house regulations.
- Precautions are provided in this manual for safe operation of the machine and prevention of injury to you or other people or other damage.
- Improper handling of the machine will cause injury or damage at various levels. The levels are classified into three categories, which are represented by respective caution symbols and signal terms to call people's attention. These symbols and terms are used in the same way on the warning labels stuck to the machine.

Caution symbol	Signal terms	Definition of terms
	DANGER	Improper handling is very likely to cause death or serious injury.
	WARNING	Improper handling can cause death or serious injury.
	CAUTION	Improper handling can cause injury or physical damage. It is also used to point out dangerous habitual action.
	Notice sign	The notice sign notifies machine operators and maintenance men of precautions as to parts of the machine or peripheral equipment that will lead to breakdown.

The serious injury mentioned above refers to loss of eyesight, injury, burns (high/medium temperature), electric shock, bone fracture, poisoning which leave an aftereffect or require hospitalization or regular treatment at a hospital for an extended period of time. The injury refers to a wound, burn, or electric shock which do not need hospitalization or regular treatment at a hospital for an extended period of time. The physical damage refers to damage to assets and extensive loss due to damage to the machine.

2 Safety precautions



WARNING

Strictly observe the following to prevent accidents resulting in serious injury or death.

- This welding machine is designed and manufactured by taking safety into consideration. However, never fail to observe the warning and precautions described in this instruction manual, otherwise accidents leading to serious injury or death can result.
- Keep people out of the space around the welding machine and working area.
- The welding machine generates a magnetic field around itself. Such a magnetic field affects certain types of sensors and clocks. For the same reason, any person who have a pacemaker in his heart shall not approach the welding machine in operation or the welding space unless he has obtained doctor's permission.
- For safety, leave the installation, maintenance, inspection, and repair of the machine to a person who has thorough knowledge about welding machines or to a qualified operator.
- For safety, leave the operation of the machine to a person with complete knowledge of the instruction manual and sufficient skill.
- Do not use this machine for any purpose other than arc welding described in the instruction manual.
- Do not remodel the machine.
- Check the safety around the machine before operation to prevent accidents.
- Be sure to hold the handle when carrying the machine.
- Wear leather gauntlets when touching the machine during welding or right after operation.
Do not touch the welded surface until it has cooled.



WARNING

Strictly observe the following to prevent electric shock.



- Do not touch the charged section; otherwise fatal electric shock or burns can result. When the power on the input side is turned on, the input circuit and the inside of the welding machine are charged. Even if the input power is turned off, the capacitor may have been charged. When the welding power is output, the electrode and base metal, as well as the metal portion in contact with these, are charged.
- Never touch charged sections.
- The welding power supply case and base metal, as well as jigs electrically connected to them, shall be grounded in conformity with the law (Technical Standard for Electric Equipment) by a qualified electric engineer.
- Turn off all power supplies on the input side by means of switches in the switch boxes before installation, maintenance, and inspection. The capacitor will not discharge completely right after the input power is turned off. Check that no voltage is remaining before maintenance or inspection.
- Periodically conduct maintenance and inspection. Repair damaged parts before resuming operation.

- Do not use cables with Insufficient capacity or damaged cables whose conductors are exposed.
- firmly tighten and insulate cable connections.
- Firmly connect the welding cable on the base metal side at a location as close as possible to the base metal.
- Do not use the machine with the welding machine case or coser removed.
- Be sure to cover the input and output terminals before use.
- Do not use broken or wet gauntlets.
- Never fail to use a life-line when working in high places.
- Turn off power switches of all devices and input-side power supply when the machine is not used.
- Do not wear wet clothes.
- Do not stand on or touch the wet floor.
- Do not use the machine outdoors when it is raining.
- Do not leave the machine outdoors after use.
- Be sure to install a fuse or breaker on the input power supply side.
- Check the supply voltage of the machine before use.
The tolerance for the input supply voltage is plus or minus 10% of the rating. Use of the machine out of the folerance is prohibited.
- The metal receptacle (plug) on the tough-rubber sheath cable is threaded. Tighten it firmly.
- Be sure to ground the tough-rubber sheath cable of the machine.
- Turn off the power and stop operation in the following cases, and ask an engineer with special knowledge of electricity to repair.
 - *Broken or worn-out cables
 - *Damage due to water leakage or other liquid
 - *Malfunction of the machine inspire of operation in conformity with the instruction manual.
 - *Breakdown of the machine.
 - *Abnormal performance of the machine which requires tune-up.
- Ask an engineer with expertise to maintain, inspect, or repair the machire.
- Please make sure that any foreign material does not attach to the connector of the machine nor to the plug of the power cable when the plug of the power cable is connected to the machine.
Foreign materials can cause short-circuits or melt the connector.
- **In case if you get connected WU-5R, make sure to Turn Off the Power.**
Caution: When the power is on if it gets connected there is a possibility of failure.

**CAUTION**

Use protective gear to protect you and others from arc light, scattered spatters/slugs, and noise.



- The arc light includes harmful ultraviolet rays and infrared rays, causing inflammation of eyes or burns.
- Scattered spatters and slugs can damage your eyes and cause burns.
- Noise can cause hearing difficulties.
- Wear light-shielding goggles or hand shield, which blocks light sufficiently, for welding operation or monitoring welding.
- Wear protective goggles to protect your eyes from spatters and slugs.
- Install a protective curtain around the welding site so that arc light will not reach the eyes of people around the site.
- Wear protective gear such as leather gauntlets, clothes with long-sleeves, leg cover, leather apron, helmet, and safety shoes.
- When the noise level is high, wear a noise-proofing protector.

**CAUTION**

Use protective gear to protect you and others from fumes and gas generated by welding.



- Welding generates fumes and gas. Inhalation of such fumes and gas can damage your health.
- Welding operation in a small space causes deficiency of oxygen, which is very likely to cause suffocation.
- To prevent gas poisoning and suffocation, use the local waste disposal facilities stipulated by the law (Industrial Safety and Health Law and Regulations to Prevent Damage due to Dust) or use an effective inhaler.
- When the welding space is small, ventilate the space sufficiently or wear an inhaler. Have a trained watchman monitor welding.
- Welding operation near places where degreasing, washing, or spraying is conducted may lead to generation of harmful gas. Do not conduct welding near such places.
- Welding zinc plated steel sheets or other coated steel sheets will generate harmful fumes. Remove the coating before welding, or wear an inhaler before operation.

**CAUTION**

Strictly observe the following to prevent gas cylinders from falling or bursting.



- Gas cylinders, when they fall, can cause accidents leading to death or injury.
- High-pressure gas is contained in gas cylinders. Improper handling of gas cylinders can cause a burst or emission of high-pressure gas, causing accidents that lead to death or injury.
- Handle gas cylinders in conformity with the law (High Pressure Gas Control Law).
- Do not expose gas cylinders to high temperatures.
- Set gas cylinders in a special cylinder stands to prevent the gas cylinders from falling.
- Never generate arcs on gas cylinders. Do not hook the welding torch on gas cylinders, or do not allow electrode to touch gas cylinders.
- Do not bring your head close to the discharge port when opening the valve on the gas cylinder.
- Attach a protective cap to gas cylinders when they are kept unused.
- Use a gas flow rate controller made or recommended by a welding machine manufacture.
- Read the instruction manual for the gas flow rate controller before use, and strictly observe the precautions.
- Never use a gas cylinder from which gas is leaking or a broken gas cylinder.
- Use gas cylinders only for specified purposes.
- DO not apply oil or grease to the valve on gas cylinders.
- When the valve on gas cylinders is hard to open, contact the dealer.

**CAUTION**

Strictly observe the following to prevent injury due to rotary section.



- Do not bring your hands, hair, or clothes close to the cooling fan of the welding power supply or the feeder roller of the wire feeder; otherwise you can be caught in them.
- Do not bring your head near the end of the welding torch during wire inching; otherwise the wire may stick in your eyes.
- When the spool of wire is released, you can get hurt.
- Do not use the welding machine with its case or cover removed.
- Ask a trained person who has thorough knowledge of welding machines or a qualified person to remove the case for maintenance, inspection, or repair. Install a protective fence around the welding machine to prevent people from getting near carelessly.
- DO not bring your hand, fingers, hair, or clothes close to the rotating cooling fan or the roller of the feeder.
- Do not bring your head near the end of the welding torch during wire inching.
- Secure the end of the wire with the wire stopper on the spool when storing or moving the spool of wire or when setting it in the wire feeder.
- When inserting the spool of wire into the wire guide on the wire feeder, firmly hold the wire so that it will not be released.

**CAUTION**

Strictly observe the following to prevent fire, explosion, or burst.



- Spatters and hot base metal right after welding can cause tire.
- Imperfect connection of cables or imperfect contact on the route of the electric current on the steel bar and other base metal can cause fire because of heating due to resistance.
- Arcs generated on the container of gasoline or other inflammables can cause explosion.
- welding of sealed tanks or pipes can cause bursts.
- Do not do welding in a place where scattered spatters will be in contact with inflammables.
- Do not do welding in a place near inflammable gas.
- Do not bring hot base metal right after welding close to inflammables.
- Welding on ceilings, floors, an walls may cause fire on the hidden side. Remove inflammables from the hidden side.
- Firmly tighten cable connections, and firmly connect the welding cable on the base metal side at a location as close as possible to the base metal.
- Do not weld gas pipes filled with gas.
- Do not weld sealed tanks or pipes.
- Provide a fire extinguisher near the welding place to prepare for the worst.
- Do not weld a container that has inflammables inside.
- Do not have a lighter, matches, or other inflammables with you during welding.

About the transport of the machine

1. When installing on carriage, be sure to hold the handle when carrying the carriage.
2. When installing on carriage, be sure to remove the carriage from the rail when moving the rail.
3. When installing on carriage, do not lift the carriage by holding its Handle. There is risk of falling off carriage while holding carriage by handle, if there is shockimpact at carriage or if mounting screw of handle is loose.

Machine noise

1. Volume of at the time of driving the machine is less than 70dB.

About external environment

1. Never use the machine outdoors when the weather is wet. This will cause failure of the machine and could cause a fatal accident by electric shock.
2. Please avoid high temperature and humidity.
3. Please use in an environment where the internal temperature is 5 ~ 70 °C.
4. Please use in an environment with internal humidity of 20 to 80% RH.

3 Location of Safety labels

Safety labels and labels for correct operations are stuck to the machine.

- Carefully read labels before operation and follow the instructions decried on them.
- Never peel off the labels. Keep them clean and legible at all times.

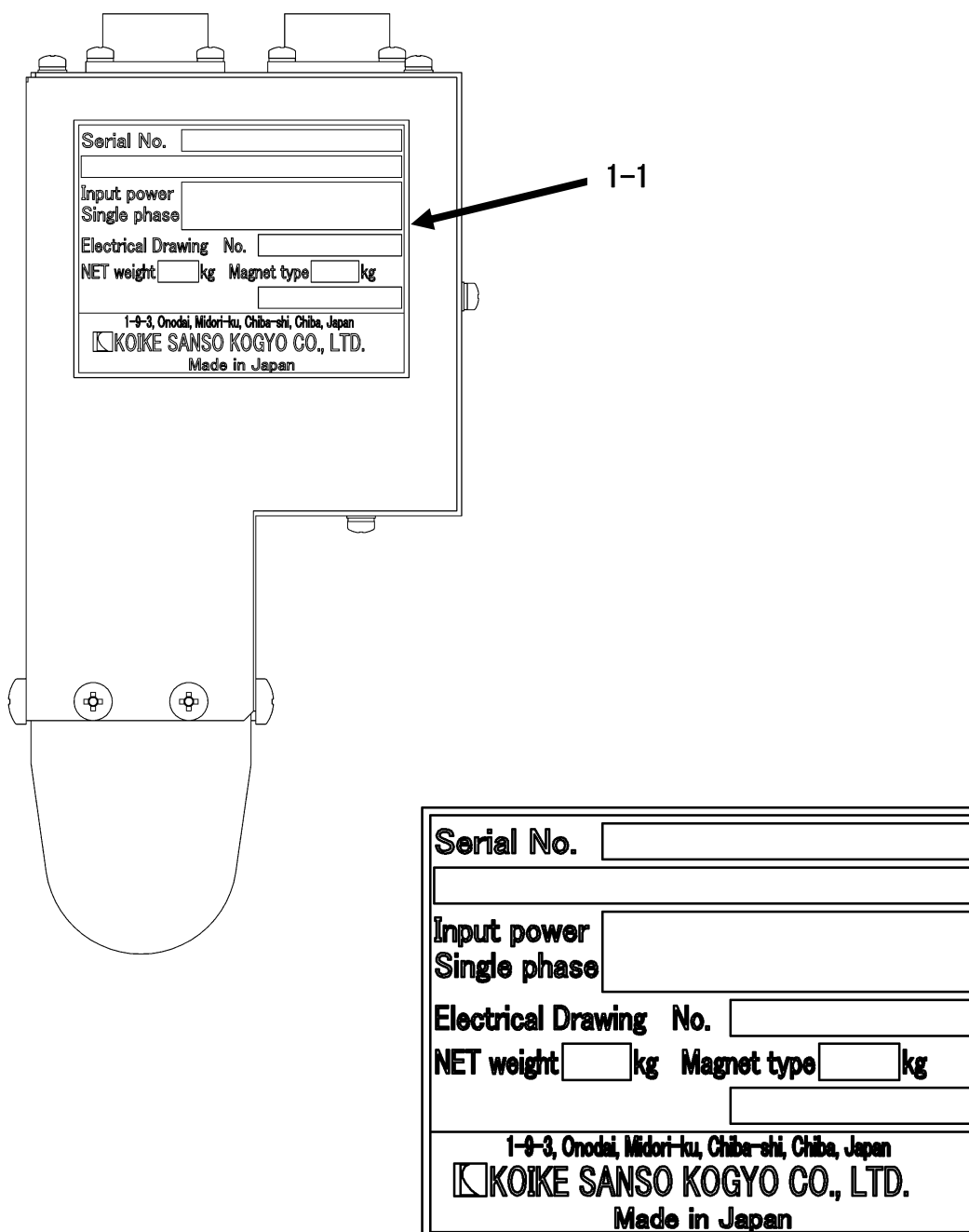

1-1

4 Features and specifications

4.1 Features

By combining "WEAVING UNIT WU-3R" with automatic welding system such as Positioner LD-RW series and WEL-HANDY MULTI NEXT TACK, weaving function can be easily installed.

1. Compact, Light weight, Durable and Low gravity.
2. Each mounting kit can be used and installed in each device. When connecting, it automatically recognizes the weaving unit and switches the software, so you can easily start using it.
3. Weaving conditions (swing speed, amplitude, stop time, origin position) can be changed from each connected device side.
4. By the origin position adjustment function, the origin alignment can be easily carried out.
5. Forward angle, back angle adjustment can be done.
6. As weaving unit has port for device addition, weaving unit can be added and operation pendant can be connected.

The above features are expected to exhibit their effects in terms of "welding efficiency" and "operation by unskilled workers."

4.2 Configuration

4.2.1 WEAVING UNIT WU-3R(Stock No : 20511084)

No	Name	QTY	Remarks
1	WEAVING UNIT WU-3R	1pc	
2	Accessories		
	Short circuit connector	1pc	Already attached to the main body
	Instruction manual, Written guarantee	each 1pc	

✂Please use the mounting kit for each device when using.

4.2.2 Torch stand mount kit (Stock No : 20505908)

No	Name	QTY	Remarks
1	MG holder	1pc	For torch stand installation (with BC-8x25 2pcs)
2	Pipe arm	1pc	350mm
3	D type holder	1set	
4	Torch holder assembly	1set	
5	Mounting bracket	1pc	
6	Connecting axis	1pc	with BC-5x12 4pcs
7	Hexagon socket head bolt	4pcs	BC-8x25
8	Washer	8pcs	WF-8
9	Washer	4pcs	WS-8
10	Nut	4pcs	NH-8
11	Hexagon socket head bolt	4pcs	BC-5x15(with WS、WF)
12	signal cable 2M	1pc	
13	Hex wrench (M5、 M6、 M8)	each 1pc	
14	Driver (+)	1pc	

4.2.3 WEL-HANDY MULTI NEXT mount kit (Stock No : 20505397)

No	Name	QTY	Remarks
1	Nameplate	1pc	
2	Holder mounting bracket	1pc	350mm
3	Weaving mounting bracket	1pc	
4	Torch holder assembly	1set	
5	Eyebolt	1pc	
6	signal cable 0.5M	1pc	
7	Hexagon socket head bolt	2pcs	BC-5x16 (with WS,WF)
8	Hexagon socket head bolt	2pcs	BC-4x12 (with WS,WF)
9	Hexagon socket head bolt	2pcs	BC-5x14 (with WS,WF)
10	Hexagon socket head bolt	9pcs	BC-5x15 (with WS,WF)
11	Hexagon socket head bolt	3pcs	BC-5x12 (with WS,WF)
12	Square nut	1pc	M5
13	Hex wrench (M4、 M5、 M6)	each 1pc	

4.2.4 TYPE-F WU-3R WEAVING HOLDER SET (Stock No: 20511065)

No	Name	QTY	Remarks
1	Stand	1pc	180L
2	Pipe arm	1pc	350L
3	Bar holder assembly	1set	
4	F type holder	1set	
5	Torch holder assembly	1set	
6	Mounting bracket	1pc	
7	Weaving harness assembly	1set	
8	Signal cable (0.5M)	1pc	
9	Weight plate	1pc	
10	Weaving unit WU-3R	1pc	
11	Hexagon socket head bolt	4pcs	BC-5 × 15 (with WS,WF)
12	Screw	1pc	SP-3 × 10 (with WS,WF)
13	Nut	1pc	NH-3
14	Hexagon bolt	2pcs	BH-10 × 30
15	Washer	2pcs	WF-10
16	Hex wrench (M5,M6)	each 1pc	
17	Driver (+)	1pc	

※ Only the IK-12 NEXT kit equipped with includes the weaving unit WU-3R main body.
Please be careful.

4.3 Specifications

4.3.1 WEAVING UNIT WU-3R

Item	Specifications
Input power supply	DC24V 1.2A
Weight	2kg/4.4lb
Carriage dimensions	L78xW91xH185mm(Includes torch holder) L3.071xW3.583xH7.283inch(Includes torch holder)
Drive motor	2 phase excitation stepping motor Step angle 1.8degrees
Mechanical section	Reduction ratio 1/318 Length From the rotation center to the torch tip 100mm / 3.94inch
Operation from connected device side	Swing speed : 400~1500mm/min / 15.7~ 59.0 inch/min Swing width : 0~100.0mm / 0~3.94inch Right torch stop time : 0~10.0s Central torch stop time : 0~10.0s Left torch stop time : 0~10.0s Origin position adjustment

4.3.2 Torch stand mount kit

Item	Specifications
Swept forward angle/sweep back angle	20°
Groove angle	0~45°
Torch adjustment range stroke	It will lower 50mm(1.969inch) than the hold position. It goes down by 70mm(2.756inch) with the screw.
Torch holder	For curved torch

4.3.3 WEL-HANDY MULTI NEXT mount kit

Item	Specifications
Swept forward angle/sweep back angle	5°
Groove angle	0~45°
Torch adjustment range stroke	Up and down : 50mm / 1.969inch Left and right : 50mm / 1.969inch
Torch holder	Shared use of curved torch and straight torch
Carriage specifications when mounted	
Item	Specifications
Applied position	Horizontal, Vertical direction
Profiling method	Standing pressing method
Driving method	Rubber roller 4 wheeler driving (permanent magnet absorption type) (Lower plate traveling system, traveling surface is steel plate)
Gross weight	12kg / 26.5lb
Traction force	15kg / 33.07lb
Dimension	L280×W330×H255~305mm L11.024×W12.992×H10.039~12.008inch
Welding reserve	Total start and end : About 330mm / 12.992 inch
Control source	AC100~240V ±10% 1.1~0.7A 50/60Hz...except Europe DC24V...Europe only
Electric power supply and interlock	Torch switch signal (connected to wire supply device) (A contact output of Self-holding type Relay)
Traceable range	Gentle curve line (more than 5m /16.4feet radius)

4.3.4 TYPE-F WU-3R WEAVING HOLDER SET

Item	Specifications
Swept forward angle/sweep back angle	5°
Groove angle	0~45°
Torch adjustment range stroke	Up and down : 115mm/4.53inch Left and right : 110mm/4.33inch
Torch holder	Shared use of curved torch and straight torch
Carriage specifications when mounted	
Item	Specifications
Weight (with WU-3R)	17 kg/37.48lb
Machine size:	432 mm/17inch
Machine width	220 mm/8.66inch
Wheel width	160 mm/6.3inch
Power source	AC100~240V ±10% 1.1~0.7A 50/60Hz
Motor	DC24V motor with an encoder 23W 5600rpm
Transmission	Dial acceleration formula, Variable speed
Traveling speed	40~2400 mm/min/1.57~94.49inch
Creep speed	40~300 mm/min/1.57~11.81inch
Speed meter	Digital display
MAX loaded weight	50 kg/110.23lb (Including IK-12 NEXT mount kit)

4.4 Name of each part

4.4.1 Torch stand mount kit

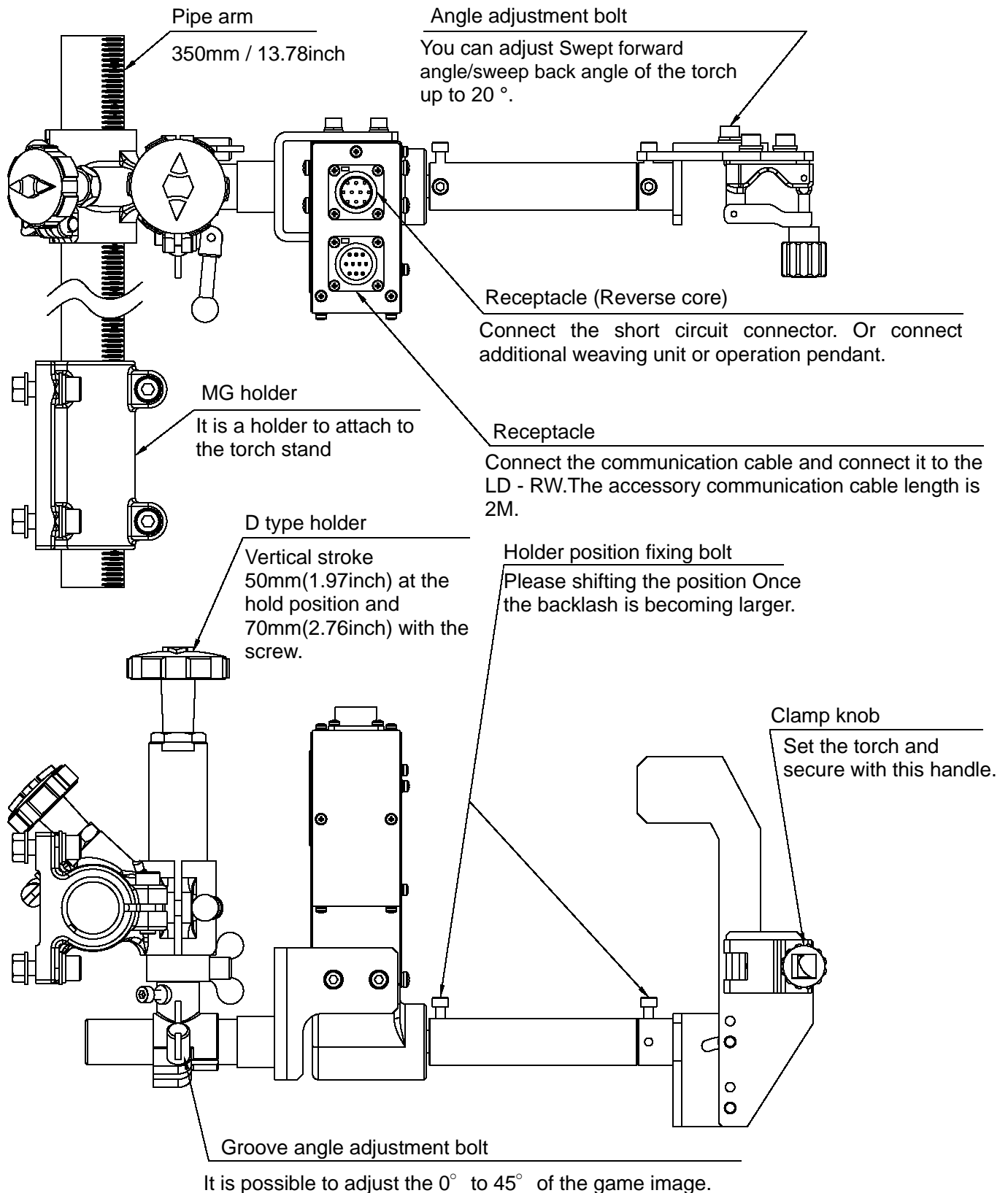

4.4.2 When using WEL-HANDY MULTI NEXT TACK mount kit

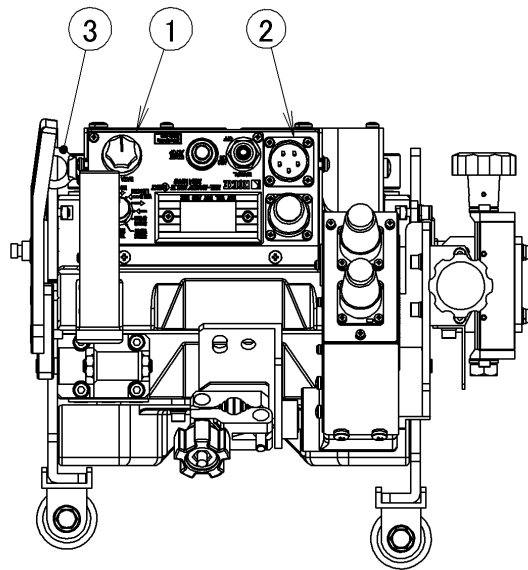

(1) **Operation panel**

The detail is shown below.

(2) **Receptacle**

Kindly connect power cable to this receptacle.



WARNING Never fail to ground the clip.



■ The grounded clip prevents short circuits or electric shock which results from a short circuit in the carriage, etc.

(3) Safety bracket

In the work of the wall and high altitude, vibration, etc.

There is a danger of the machine to fall.

For prevention of fall please work with ropes always attached at both ends to safety fittings fixed securely through rope etc.

Eyebolts can be mounted on either the left or right side of the carriage body.

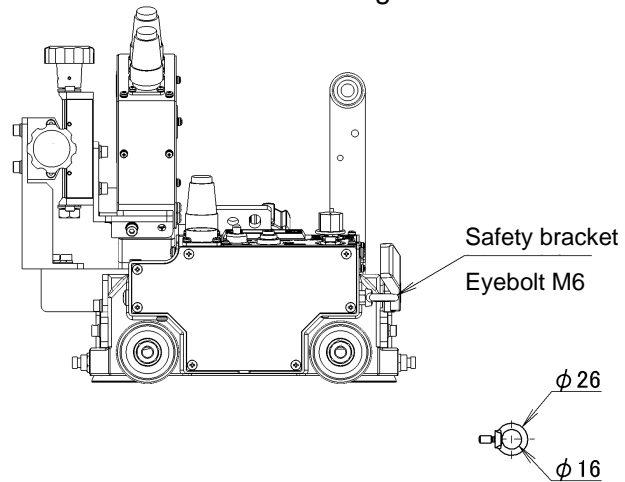

Please refer to the separate manual "WEL-HANDY MULTI NEXT TACK" instruction manual for other carriage body functions.

4.4.3 When using TYPE-F WU-3R WEAVING HOLDER SET

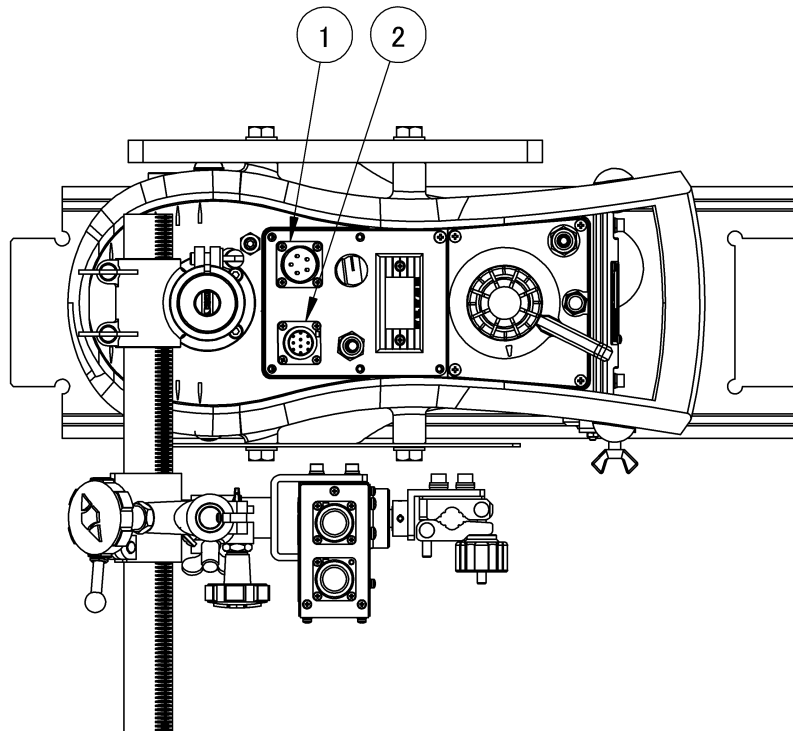

(1) Receptacle

Kindly connect power cable to this receptacle.

	WARNING Never fail to ground the clip.
	■ The grounded clip prevents short circuits or electric shock which results from a short circuit in the carriage, etc.

(2) Weaving harness assembly

Connect the signal cable to this receptacle.

The signal cable is connected to this operation panel and weaving unit.

	WARNING Never fail to ground the clip.
	■ The grounded clip prevents short circuits or electric shock which results from a short circuit in the carriage, etc.

Please refer to the separate manual "IK-12 NEXT" instruction manual for other carriage body functions.

5 Preparation for operation

5.1 Torch stand mount kit

5.1.1 Configuration

Packing the contents of the mount kit is as follows. Please check before assembling.

1. MG holder(with bolt 2pcs) -----1pc
2. D type holder -----1set
3. Torch holder assembly-----1set
4. Mounting bracket-----1pc
5. Connecting axis (with hexagon socket bolt 4pcs) -----1pc
6. Hexagon socket bolt BC-8x25-----4pcs
7. Washer WF-8 -----8pcs
8. Washer WS-8 -----4pcs
9. Hexagon nut NH-8-----4pcs
10. Hexagon socket bolt BC-5x15(with WS、WF)-----4pcs
11. Signal cable 2M (St.No.61006556)-----1pc
12. Pipe arm 350L -----1pc
13. Hex wrench (M5、M6、M8)-----each 1pc
14. Driver (+) -----1pc
15. Instruction manual, Written guarantee ----- each 1pc

5.1.2 Machine Assembly

1. Remove the parts of mount kit from the box.
2. Connect the connecting axis and the drive shaft of WEAVING UNIT.
3. To secure torch holder assembly to connecting axis.
4. To secure WEAVING UNIT and mounting bracket with Hexagon socket bolt BC-5x15(with WS、WF).
5. Insert Mounting bracket in torch holder base of D type holder and fix it.
6. To secure torch stand and MG holder with Hexagon socket bolt BC-8x25, Washer WF-8, Washer WS-8, Hexagon nut NH-8.
7. Pipe arm to secure it to MG holder and D type holder.
8. Connect Short circuit connector to Reverse core receptacle.
9. Connect signal cable to receptacle and connect the other to CN-SIO of LD-RW.



CAUTION

In case if you get connected WU-3R, make sure to Turn Off the Power.

- When the power is on if it gets connected there is a possibility of failure.

Mounting completion drawing is as follows

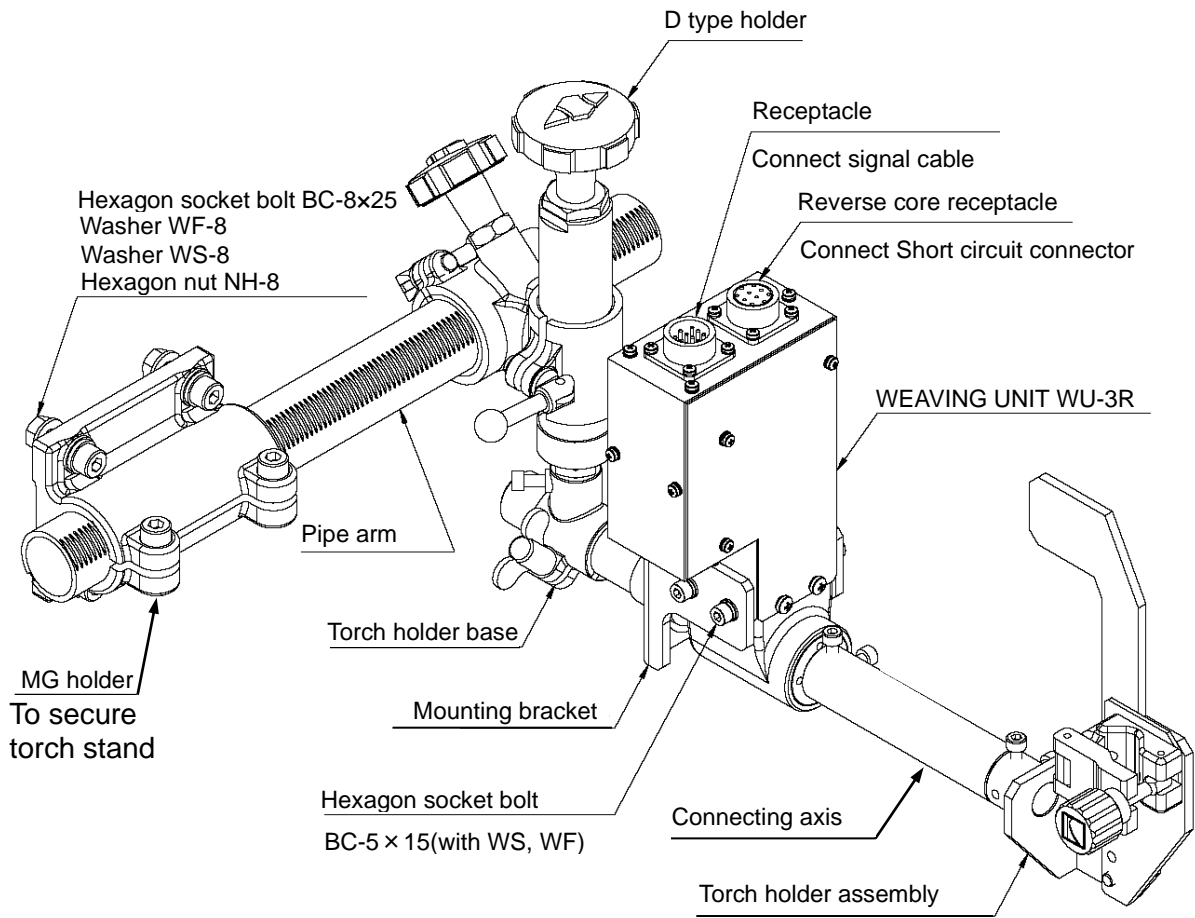

LD-60RW operation panel diagram

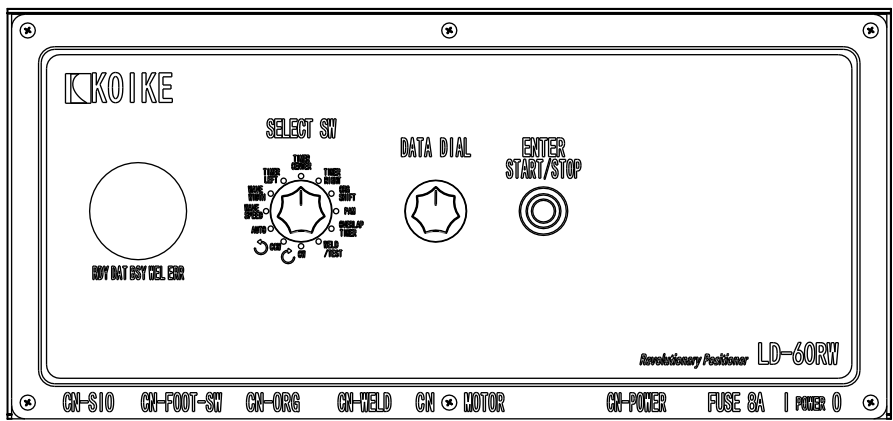

↑
Connect signal cable to CN-SIO.

5.2 WEL-HANDY MULTI NEXT mount kit

5.2.1 Configuration

Packing the contents of the mount kit is as follows. Please check before assembling.

- | | | |
|-----|--|----------|
| 1. | Operation panel name plate(for weaving)----- | 1pc |
| 2. | Holder mounting bracket----- | 1pc |
| 3. | Weaving mounting plate ----- | 1pc |
| 4. | Torch holder assembly----- | 1set |
| 5. | Eye bolt M6 (with nut) ----- | 1pc |
| 6. | Signal cable 0.5M----- | 1pc |
| 7. | Hexagon socket bolt BC-5×16 (with WS,WF) ----- | 2pcs |
| 8. | Hexagon socket bolt BC-4×12 (with WS,WF) ----- | 2pcs |
| 9. | Hexagon socket bolt BC-5×14 (with WS,WF) ----- | 2pcs |
| 10. | Hexagon socket bolt BC-5×15 (with WS,WF) ----- | 9pcs |
| 11. | Hexagon socket bolt BC-5×12 (with WS,WF) ----- | 3pcs |
| 12. | square nut M5----- | 1pc |
| 13. | Hex wrench (M4,M5,M6) ----- | each 1pc |

5.2.2 Machine Assembly

1. Remove the parts of mount kit from the box.
2. Remove slide unit bracket, slide unit, fixing holder from WEL-HANDY MULTI NEXT TACK. Remove control panel attached to operation panel name plate.(※If you remove operation panel name plate, also remove Glass support.)
3. Fix the removed slide unit and weaving mounting plate with Hexagon socket bolt BC-5×15(with WS,WF).
4. Fix WEAVING UNIT and weaving mounting plate with Hexagon socket bolt BC-4×12(with WS,WF) and Hexagon socket bolt BC-5×14(with WS,WF).
5. Fix WEL-HANDY MULTI NEXT TACK and Holder mounting bracket with Hexagon socket bolt BC-5×15(with WS,WF) and square nut M5.
6. Fix Holder mounting bracket and slide unit bracket with Hexagon socket bolt BC-5×12(with WS,WF).
7. Fix slide unit bracket and slide unit with Hexagon socket bolt BC-5×15(with WS,WF).
8. Attach Operation panel name plate(for weaving) to control panel
9. Attach Eye bolt M6 (with nut) to WEL-HANDY MULTI NEXT TACK.
10. Attach handle attached to WEL-HANDY MULTI NEXT TACK by turning 90 °.
10. Connect signal cable to receptacle and connect the other to control panel of WEL-HANDY MULTI NEXT TACK.

**CAUTION**

In case if you get connected WU-3R, make sure to Turn Off the Power.

- When the power is on if it gets connected there is a possibility of failure.

Mounting completion drawing is as follows

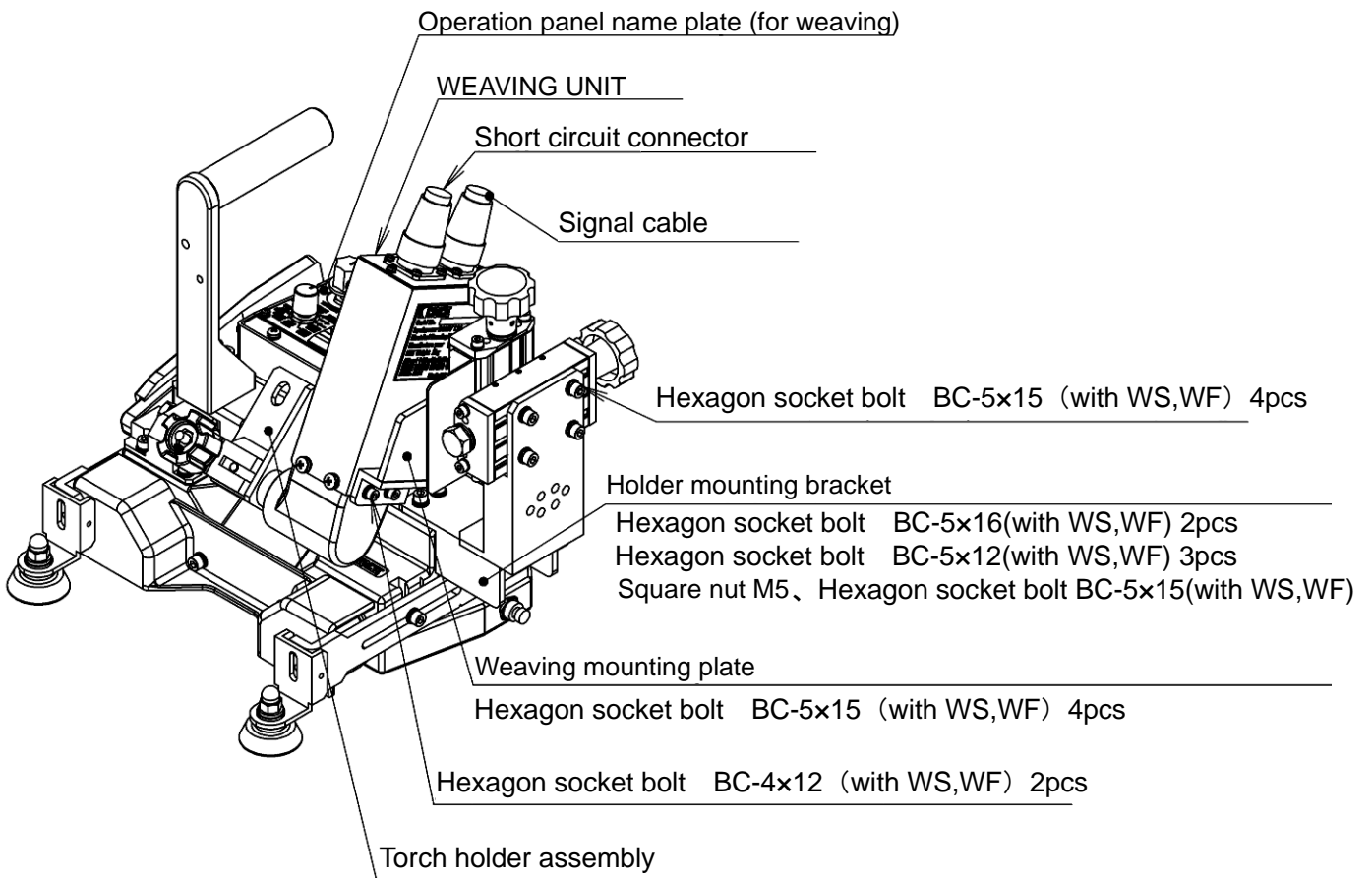

5.3 TYPE-F WU-3R WEAVING HOLDER SET

5.3.1 Configuration

Packing the contents of the mount kit is as follows. Please check before assembling.

- | | | |
|--|-------|------|
| 1. Stand | ----- | 1pc |
| 2. Pipe arm | ----- | 1pc |
| 3. Bar holder assembly | ----- | 1set |
| 4. F type holder + Torch holder assembly + Mounting bracket + Weaving unit | ---- | 1set |
| 5. Weaving harness assembly | ----- | 1set |
| 6. Signal cable (0.5M) | ----- | 1pc |
| 7. Weight plate | ----- | 1pc |
| 8. Screw SP-3 × 10 (WS,WF) | ----- | 1pc |
| 9. Nut NH-3 | ----- | 1pc |
| 10. Hexagon bolt BH-10×30 | ----- | 2pcs |
| 11. Washer WF-10 | ----- | 2pcs |
| 12. Hex wrench (M5、 M6) | ----- | 1pc |
| 13. Driver (+) | ----- | 1pc |

5.3.2 Machine Assembly

1. Remove the parts of mount kit from the box.
2. Remove the stand from IK – 12 NEXT.
3. Remove the four small screws (SP-3x5) that secure the control panel cover plate and remove the operation panel blind plate from the operation nameplate.

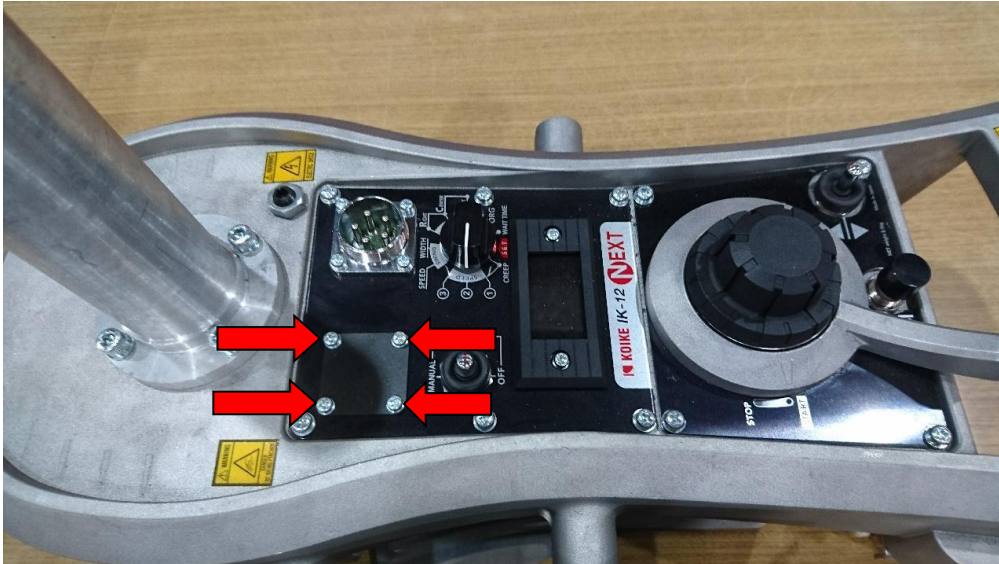

The WU-3R receptacle fits in place of the removed control panel blind plate.

Please be careful not to lose the control panel cover plate when removing the WU-3R receptacle, as it will leave the equipment without a cover.

4. Remove the six small screws (SP-4 × 10) that secure the operation nameplate and lift it up.

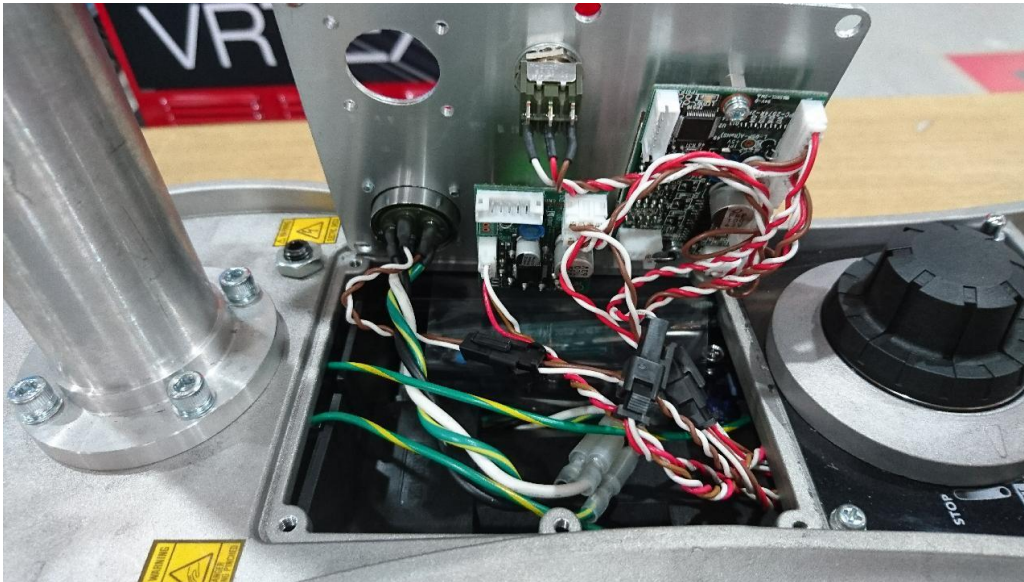
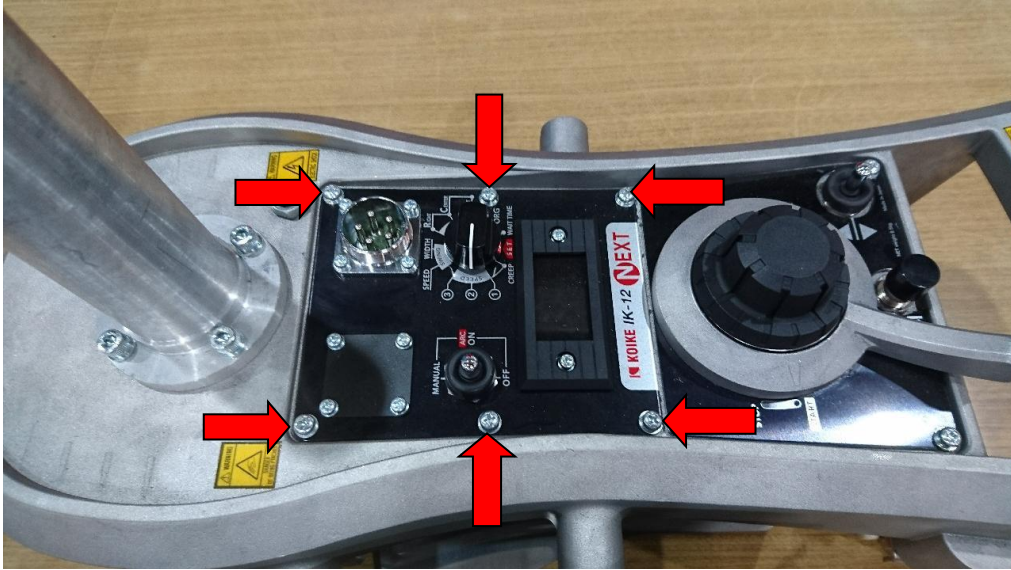

Note: The back of the operation nameplate has many wires connected to it. Please handle it carefully and avoid pulling or applying excessive force to it.

5. Fix the WU-3R receptacle to the operation nameplate using the three small screws for fixing the plate that were removed in step1.

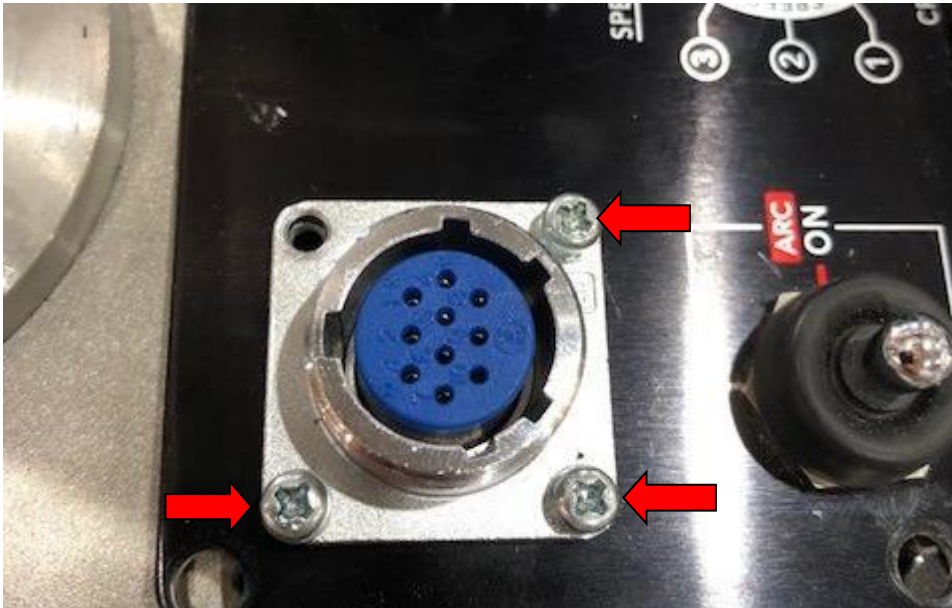

6. Insert the remaining small screw hole and tighten the supplied small screw (SP-3x12). Secure the grounding terminal of the WU-3R receptacle to the back of the operation nameplate with the supplied nut(M3).

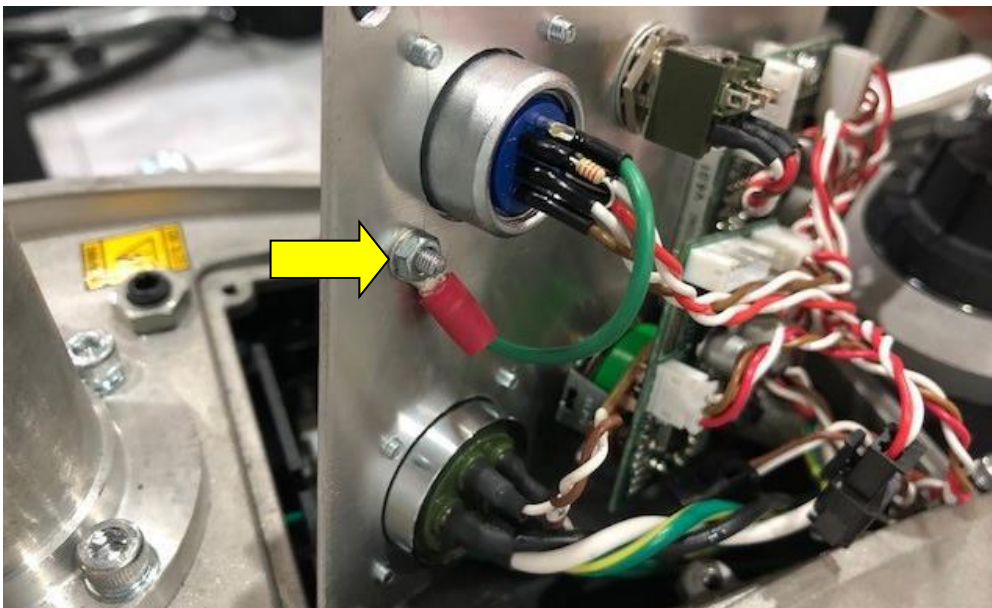

Note: Please attach the grounding wire to the mounting screw of the WU-3R receptacle. Due to size limitations, it is not possible to pass the grounding wire terminal through a small screw (SP-4x10) and secure it with the operation nameplate mounting screw.

7. Connect the WU-3R receptacle connector to the DSP-CN4 socket on the L-DSP-A board.

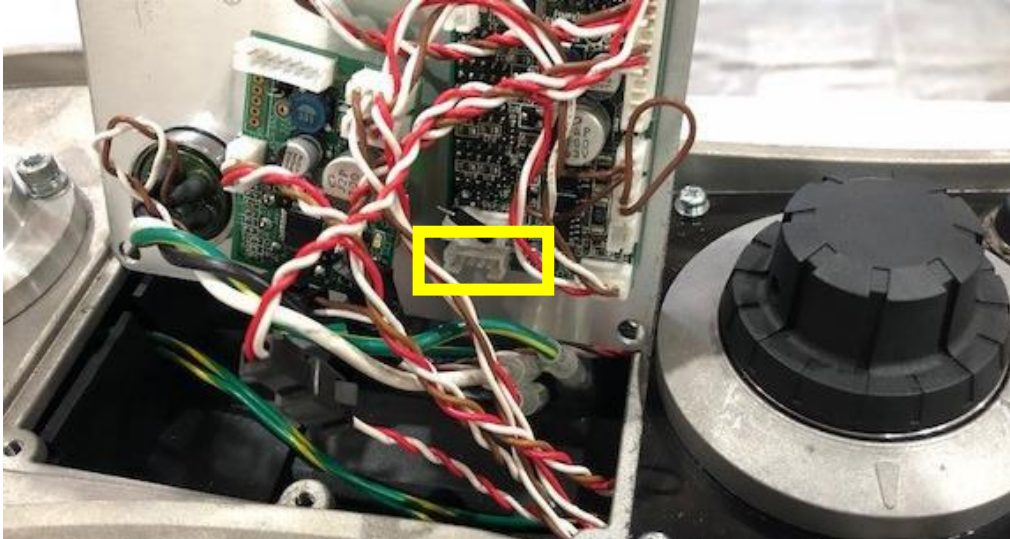

When viewed from this direction, there is an empty socket [DSP-CN4] located in the lower left corner of the L-DSP-A board.

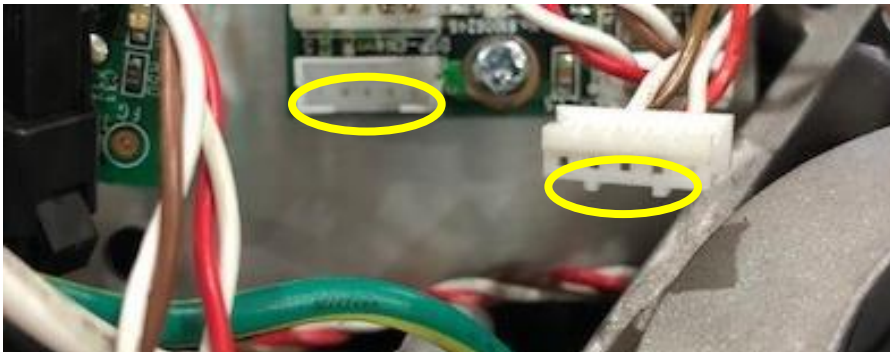

Please pay attention to the orientation and connect it so that the protrusions on the connector match the sockets on the board.

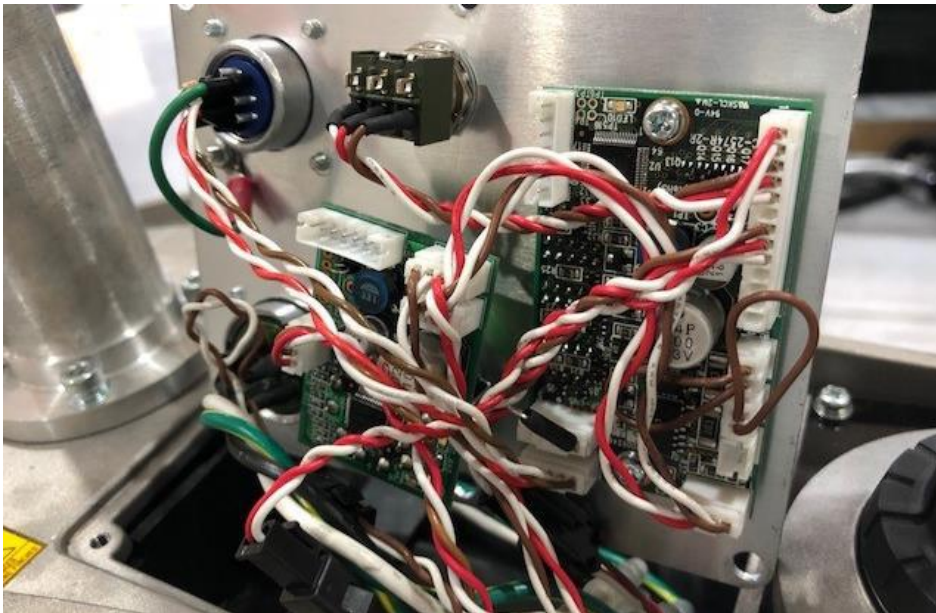
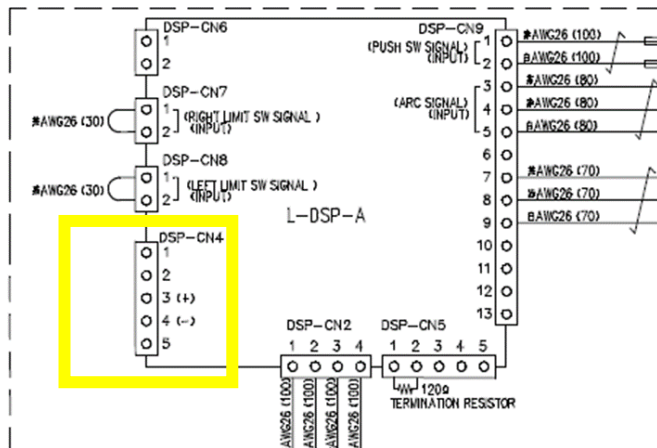

8. Once you have reattached the operation nameplate to the main unit, the installation of the WU-3R receptacle is complete.

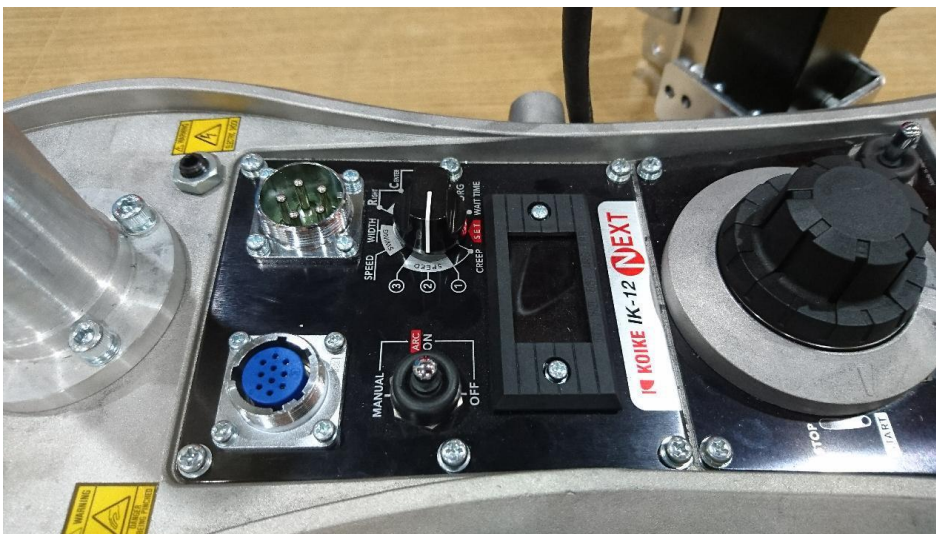

Note: When closing the operating nameplate, be careful not to put any stress on the internal wiring or bend the connector and wiring connections too much. Doing so many results in malfunctions such as poor contact or wire breakage. Please perform the operation with care to avoid putting any load on the wiring.

9. Fix Weight plate with Hexagon bolt BH-10×30 and Washer WF-10.
10. Secure the included stand with the hexagon socket bolt that was used for the existing stand.
11. Fix the Bar holder assembly to the stand.
12. Insert pipe arm in the Bar holder assembly and F type holder and fix.
13. Connect the Signal cable plug to the receptacle of the weaving unit. Connect the plug on the opposite side of the Signal cable to the operation panel of K-12 NEXT.

 CAUTION	In case if you connected WU-3R make sure Turn Off the Power
■ When the power is on if it gets connected there is a possibility of failure	

Mounting completion drawing is as follows

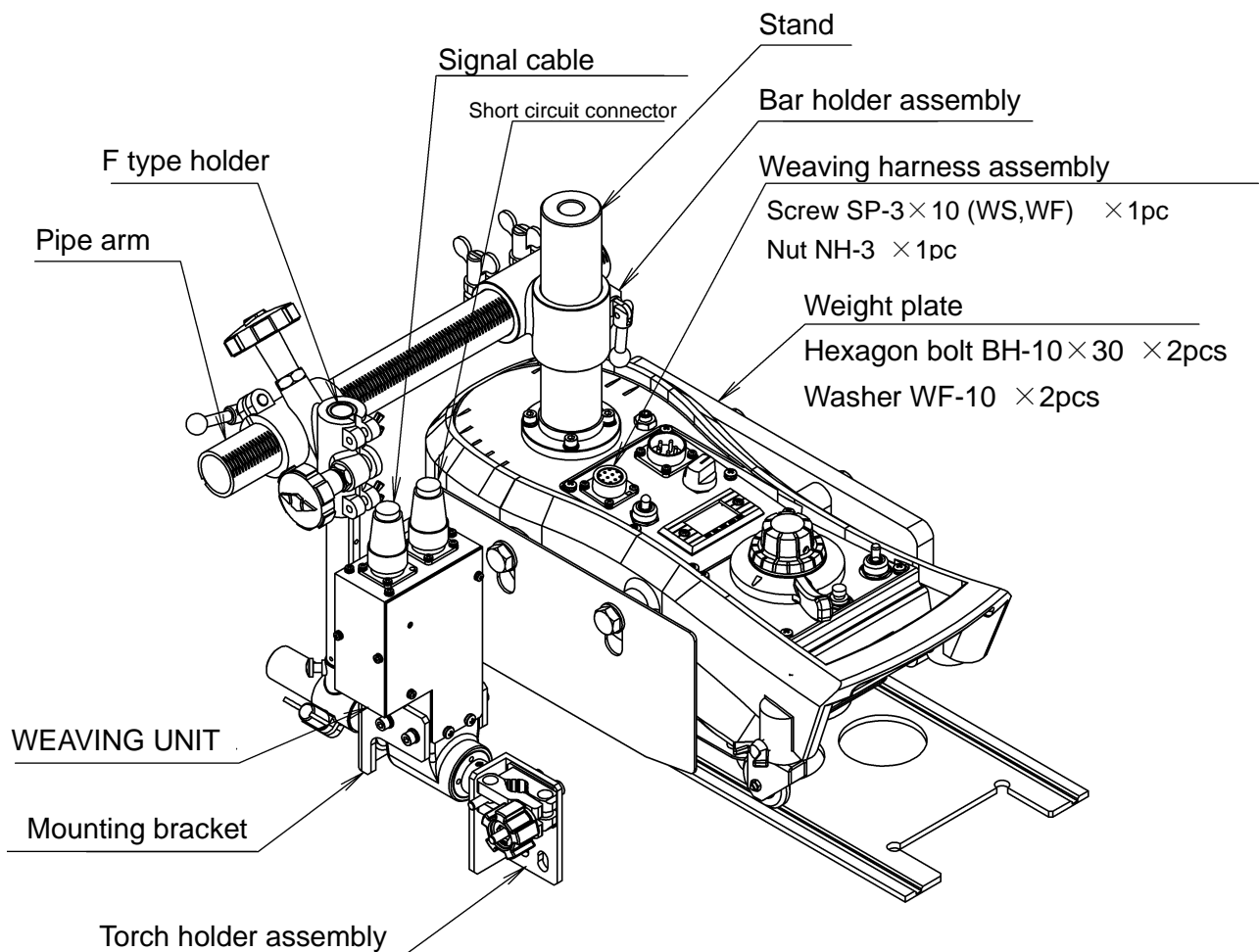

6 Preparation and welding operation



6.1 Torch stand mount kit

Regarding the operation method and welding operation, refer to separate manual "Instruction Manual of Positioner LD - RW"

6.2 WEL-HANDY MULTI NEXT TACK mount kit

V4.02

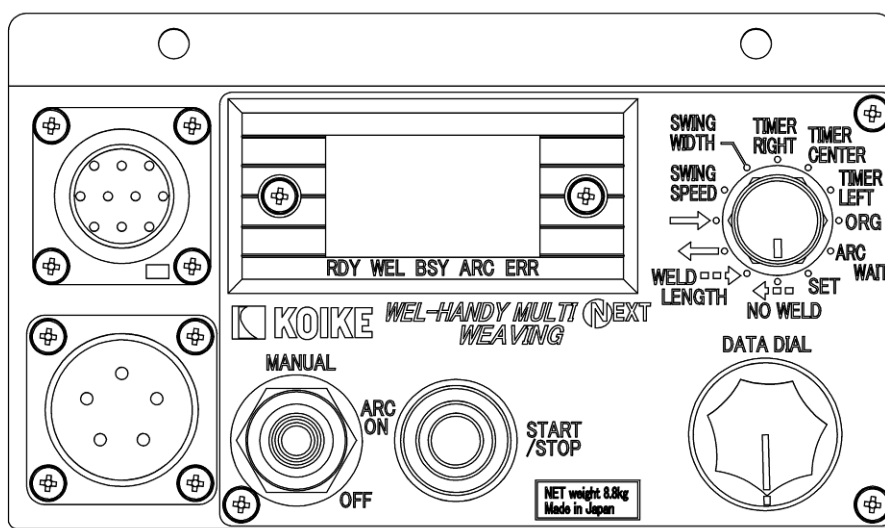

6.2.1 Operation panel

 WARNING	<p>Kindly take care about following things to avoid getting an electric shock.</p>
	<p>■ Kindly remove input plug from outlet while checking, dis-assembling or repairing and turn OFF the control source while leaving. If it is necessary to carry out checking in the energized state, professional engineer having enough knowledge and skill about electric handling should go since there is risk of short circuit, getting electric shock.</p>
<ul style="list-style-type: none"> ■ Do not use welding equipment without case or cover. ■ Kindly use power outlet with earth pin outlet since input plug has earth pin. It is connected to main body of carriage in operation panel. ■ Kindly use input voltage within $\pm 10\%$ for power supply input to input plug. There is risk of short circuit due to failure of printed board on operation panel. ■ In case of crack in insulation cover of power cable and torch cable, do not expose it to high temperature. There is risk of short circuit due to tearing of insulation covering. ■ Kindly place power cable and torch cable in proper manner so that they are not stretched or pulled. There is possibility of breakage of insulation by damaging holding part and connector part due to pulling. ■ Never fail to turn OFF the power switch (1) before attaching or detaching the receptacle. ■ When you remove the plug, put rubber cap on the receptacle to prevent dust and dirt. ■ When you found dust and dirt in the receptacle, remove these before connecting electric power cable plug. 	

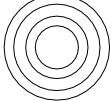

Operation panel

6.2.2 Explanation about operation Unit functions

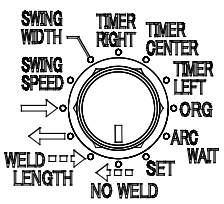
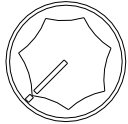
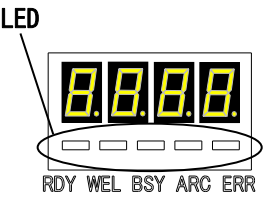
Display	Name	Function
 <p>START/STOP</p>	START/STOP Button	<p>It is used at the time of start/stop of travelling of carriage. Moreover, there are cases where this function is used to set parameters</p> <p>※When an error occurs, the error display is reset when you press the START / STOP switch. However, error if there is still cause of the error occurs again. Check each error solution, please remove the cause.</p>
 <p>MANUAL ARC ON OFF</p>	Arc changing over switch	<p>There can be 3 modes of changing over in 3 point changing over switch as shown below.</p> <p>MANUAL: Kindly use it in wire inching and arc test. Wire comes out only while switch is on MANUAL.</p> <p>※ Kindly take care as Arc is generated if torch end is touching welding material.</p> <p>ARC ON: Kindly use this position in normal welding operation. carriage starts traveling automatically after start of welding by pressing START/STOP button.</p> <p>ARC OFF: Only traveling of carriage is possible without welding operation by pressing START/STOP button at this position. Further it is used to change welding distance, preliminary feeding distance, welding return distance during traveling of Tack/Stitch carriage</p> <div style="border: 1px solid black; padding: 5px;"> <p> Caution Please do not press the START / STOP button while you are down to MANUAL side.</p> <p>• Press the START / STOP button while you are down to MANUAL side, and back to the ARC ON continues to output the arc signal, and then traveling trolley and to ARC OFF. Again, the running of the arc output and the truck and press the START / STOP button will stop. Please be when subjected to the above-mentioned operation and restart to turn OFF the power once.</p> </div>
 <p>SWING WIDTH SWING SPEED WELD LENGTH TIMER RIGHT TIMER CENTER TIMER LEFT ARC NO WELD SET WAIT</p>	SELECT SWITCH	<p>It is used for selecting each parameter and traveling mode. Kindly verify Regarding SELECT SWITCH for each parameter.</p>
 <p>DATA DIAL</p>	DATA DIAL	<p>It is used in setting carriage travelling speed and each parameter. It increases the value at clockwise rotation and decreases at anti-clockwise rotation. Moreover, it outgrows increase/decrease of value at swift rotation.</p>
 <p>LED RDY WEL BSY ARC ERR</p>	Digital Meter	<p>It displays carriage travelling speed or value of each parameter. Operation status of carriage can be known from LED display of digital meter.</p> <p>RDY: It turns ON when electric supply of carriage is ON.</p> <p>WEL: It turns ON when welding signal is displayed while carriage is travelling.</p> <p>BSY: It turns ON during carriage is operating regardless of display/non display of welding signal.</p> <p>ARC: It turns ON at option of MANUAL, ARCON in (5) arc mode changing over switch.</p> <p>ERR: It turns ON at generation of operation error. At this time corresponding error number of error content is displayed on digital display</p>

<About error numbers> Error indications are three-digit numbers that start with "E.". Example indication **E010**



Error number	Error details	Cause	Corrective action
001	Link unit configuration failure error	There may be a contact failure in the wiring between electrical boards (connector numbers CN2, 3 for all boards in common, connector numbers CN4, 5 for the L-DSP display board).	Check for cable disconnections, and for contact failures of connectors and crimp-type terminals. (The LEDs on each board will flash when the power is turned on: if the LEDs do not flash or light, the circuit board may be faulty.)
002	Power failure detection error	This is an error that occurs on other equipment.	In the event that it is displayed, contact the distributor where you purchased this product or our sales office.
003	Inverter error		
004	Emergency stop error		
005	3-phase power supply error		
006	Breaker OFF error		
007	Encoder line connection error	The encoder line may be connected to MD-CN10 on the L-MD-A board.	Connect the encoder line to MD-CN5.
008	Motor deviation error	There may be a contact failure on the motor line or the encoder line.	Check for disconnections in all wires, and for contact failures of connectors and crimp-type terminals. Connect the motor line to MD-CN4, and the encoder line to MD-CN5, on the L-MD-A board.
010	Welding current detection signal ON timeout (5 seconds) error	This is an error that occurs on other equipment.	In the event that it is displayed, contact the distributor where you purchased this product or our sales office.
011	Signal logic inversion error while detecting welding current		
012	Encoder selection error		
013	Unit configuration unsuitable error		
014	Weld movement distance during tack operation error	Welding distance setting is 0.	Please set the welding distance setting to 1 mm or more.
016	Servo driver error	This is an error that occurs on other equipment.	In the event that it is displayed, contact the distributor where you purchased this product or our sales office.
017	Copying signal error		
018	Thermal guard error		
019	Thermal guard error		
020	Link unit configuration failure error		
021	X-axis-direction derailing error		
022	Y-axis-direction derailing error		
023	Z-axis-direction derailing error		
024	Motor overload error (encoder equipped)	An abnormal load may be being applied to the drive section or motor.	Remove any abnormal load from the drive section or motor.
025	Carriage backup error (Parameter)	It is possible that the power was turned off during carriage operation or fine adjustment movement by limit switch, and the backup was not implemented correctly.	Turn the power off and back on again. If the error display indication is not cleared after repeating the above several times, replace all the circuit boards being used.
026	Carriage backup error (System Parameters)		
125	WU-5R backup error (parameter)	This is an error that occurs on other equipment.	In the event that it is displayed, contact the distributor where you purchased this product or our sales office.
126	WU-5R backup error (System Parameters)		





※ To recover from an error, unplug the power cable from the operation panel, turn off the power supply, check the corrective action described above, plug the power cable back into the operation panel and turn the power back on.

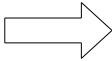
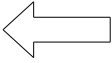
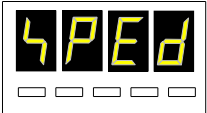

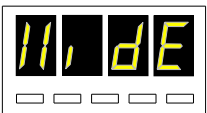

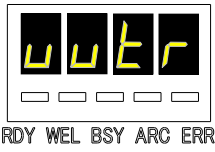
※ When an error occurs, the error indication is reset by pressing the START/STOP button, but eliminate the cause by referring to the corrective action described above before pressing the button.



6.2.3 Regarding SELECT SWITCH

When mounted in WEL-HANDY MULTI NEXT TACK using **WEL-HANDY MULTI NEXT mount kit**, weaving welding and tack welding operation become possible by selecting each mode and each parameter with SELECT SWITCH. Regarding each mode and each parameter it is given as below.

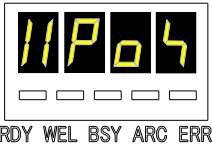
Operation unit display	Digital display	Setting range	Factory default
TRUCK SPEED  	 RDY WEL BSY ARC ERR	50~1500mm/min	—
		2.0~59.0inch/min	
		Function	
		<p>Continuous traveling mode It is used when carriage is to be run continuously. When this mode is selected, carriage starts traveling in the direction of directing arrow by pressing START/STOP button. It shows carriage traveling speed value during stop and traveling operation. It is possible to change carriage traveling speed by turning DATA DIAL during stop and traveling of carriage.※Running speed of tack/stitch driving mode of the carriage also set here. Kindly turn DATA DIAL in clock wise direction to increase speed of carriage and in anti-clock wise direction to reduce speed.</p>	
SWING SPEED	 RDY WEL BSY ARC ERR	400~1500mm/min	400mm/min
		15.7~59.0inch/min	15.7inch/min
		Function	
		<p>Weaving swing speed setting Selecting when setting the swing speed during weaving operations. ※Weaving swing speed of tack/stitch driving mode also set here. During the stop in the digital meter, swing speed value is displayed. Swing speed can be changed by turning DATA DIAL during the stop. Swing speed can be changed during the carriage driving by combined SELECT SWITCH to SWING SPEED. In a state in which combined to SWING SPEED if you press the START / STOP button, weaving works alone. (An arc does not occur at the time of the movement alone)</p>	
SWING WIDTH	 RDY WEL BSY ARC ERR	0~100.0mm	10.0mm
		0~3.94inch	0.39inch
		Function	
		<p>Weaving swing width setting Selecting when setting the swing width during weaving operations. ※Weaving swing width of tack/stitch driving mode also set here. During the stop in the digital meter, swing width value is displayed. Swing width can be changed by turning DATA DIAL during the stop. Swing width can be changed during the carriage driving by combined SELECT SWITCH to SWING WIDTH. In a state in which combined to SWING WIDTH if you press the START / STOP button, weaving works alone. (An arc does not occur at the time of the movement alone)</p>	

Operation unit display	Digital display	Setting range	Factory default
TIMER RIGHT		0~10.0s	0s
		Function	
		<p>Right torch stop time setting Selecting when setting the right torch stop time during weaving operations. Right torch stop time of tack/stitch driving mode also set here. During the stop in the digital meter, right torch stop time value is displayed. Right torch stop time can be changed by turning DATA DIAL during the stop. Right torch stop time can be changed during the carriage driving by combined SELECT SWITCH to TIMER RIGHT. In a state in which combined to TIMER RIGHT if you press the START / STOP button, weaving works alone. (An arc does not occur at the time of the movement alone)</p>	
TIMER CENTER		0~10.0s	0s
		Function	
		<p>Central torch stop time setting Selecting when setting the central torch stop time during weaving operations. Central torch stop time of tack/stitch driving mode also set here. During the stop in the digital meter, central torch stop time value is displayed. Central torch stop time can be changed by turning DATA DIAL during the stop. Central torch stop time can be changed during the carriage driving by combined SELECT SWITCH to TIMER CENTER. In a state in which combined to TIMER CENTER if you press the START / STOP button, weaving works alone. (An arc does not occur at the time of the movement alone)</p>	
TIMER LEFT		0~10.0s	0s
		Function	
		<p>Left torch stop time setting Selecting when setting the left torch stop time during weaving operations. Left torch stop time of tack/stitch driving mode also set here. During the stop in the digital meter, left torch stop time value is displayed. Left torch stop time can be changed by turning DATA DIAL during the stop. Left torch stop time can be changed during the carriage driving by combined SELECT SWITCH to TIMER LEFT. In a state in which combined to TIMER LEFT if you press the START / STOP button, weaving works alone. (An arc does not occur at the time of the movement alone)</p>	
ORG		—	—
		Function	
		<p>Origin position adjustment setting During the carriage stopped or carriage traveling by turning the DATA DIAL you can adjust the position of the origin of the torch. Turn the DATA DIAL clockwise, the torch moves to the left. Turn in the counter-clockwise direction, the torch moves to the right.</p>	

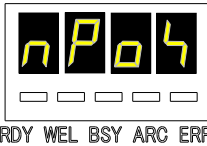
Operation unit display	Digital display	Setting range	Factory default
ARC WAIT		0~10.0s	0.5s
		Function	
<p><u>Arc stability time setting (It shows time till start of travelling of carriage after Arc ON)</u></p> <p>This mode is selected to set Arc stability time at the time of continuous travelling mode and WEAVING TACK travelling mode.</p> <p>It is time till start of travelling of carriage by pressing START/STOP button. It carries out welding while carriage is in stop state during Arc stability time and countdowns digital meter time.</p> <p>It displays Arc stability time value on the digital meter while carriage is in stop state.</p> <p>Arc stability time can be changed by turning DATA DIAL only while carriage is in stop state.</p>			
			<p>Since welding is carried out in Arc stability time by initial Arc current, it is necessary to set initial Arc settings at welding current end.</p> <p>Though Arc stability time at carriage end is from start to last, it is from the time of pressing of START/STOP button (Arc signal ON) till travelling of carriage.</p> <p>Kindly verify operation manual of welding current for initial Arc setting.</p>
ARC WAIT			
Operation unit display	Digital display	Setting range	Factory default
WELD LENGTH		1~999.9mm	20.0mm
		0.1~39.4inch	0.8inch
		Function	
<p><u>Weaving tack/stitch driving mode and welding distance setting</u></p> <p>Carriage is selected by you when weaving tack/stitch run is done, also you select welding distance at the time of tack/stitch run.</p> <p>Press the START/STOP button while selecting this mode starts the running of the carriage in the direction of the arrow.※</p> <p>While weaving welding, tack/stitch running is done.</p> <p>During the stop in the digital meter, welding distance value is displayed.</p> <p>Welding distance at the time of tack/stitch welding can be changed by turning DATA DIAL during the stop.</p> <p>If you want to change the welding distance in weaving tack/stitch traveling, the SELECT SWITCH</p> <p>To change from match to WELD LENGTH, or you can change the operation of the arc changeover switch.</p> <p>(Please refer to page 26 for more information on how to change.)</p>			
			<p>When it is set to 0mm/0inch, it displays error and it is not possible to operate.</p> <p>Kindly operate by setting at more than 1mm or 0.1inch.</p>
Carriage traveling speed will run with the value of the continuous running mode (CARRIAGE SPEED).			

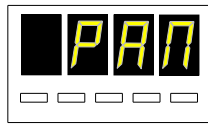
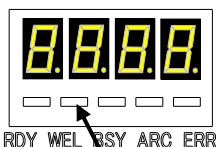
Operation unit display	Digital display	Setting range	Factory default
NO WELD 		1 ~ 999.9mm	20.0mm
		0.1 ~ 39.4inch	0.8inch
Function			
<u>Preliminary feeding distance settings (It shows length of the portion not to be weld)</u>			
This mode is selected to set preliminary feeding distance at the time of weaving tack/stitch travelling mode. It displays preliminary feeding distance value on the digital meter at stopping of carriage.			
It is possible to change the preliminary feeding distance at weaving tack/stitch welding by turning DATA DIAL while carriage is stopped.			
It is possible to change preliminary feeding distance during carriage travelling by matching SELECT SWITCH to NO WELD or by Arc changing over switch operation. (Kindly refer to page no.26 for change method details)			
Kindly always keep the carriage maximum speed of travelling during preliminary feeding distance as (1500mm/min) / (59.0inch/min).			
Operation unit display	Digital display	Setting range	Factory default
SET		0000 ~ 0010	—
		Function	
<u>Parameter setup mode</u>			
Each parameter can be set from this mode. ※ This mode can be operated only while carriage is in stop state.			
Details about parameter numbers are given below.			
※ For more information please refer to each function of the SELECT SWICTH .			
For more information on the parameters number, please check <u>Parameter number details.</u>			
1) Turn SELECT SWITCH and			
			
and match it.			
2) Select the parameter number to be changed by turning DATA DIAL.			
3) Set by pressing START/STOP button.			
4) Edit by turning DATA DIAL. It turns ON WEL of LED during editing.			
			
Turn ON			
5) Set by pressing START/STOP button after completion of editing.			
※) While initializing, turn OFF electric supply for once after above mentioned operation, and turn ON the electric supply again and complete the operation.			

Parameter number details

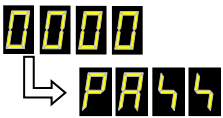
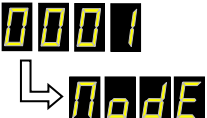
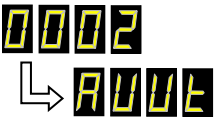
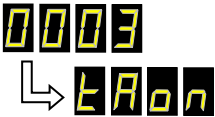
Parameter number	Function																		
	<p>Unintended input prevention setting Parameter editing is enabled when the value of this parameter is 0114. If it is any other value, input is possible only for this parameter. Use this to prevent unintended input. Setting range : 0000~9999 Factory default : 0114</p>																		
	<p>Additional Settings for the Travel Function Setting range : 0~7 Factory default : 0 Enable the addition of functions when the carriage is traveling. As the setting value, enter the sum of the values A for the individual items. Example: To turn B0 (value A = 1) and B2 (value A = 4) ON: Set value = 1 + 4 = 5</p> <table border="1"> <thead> <tr> <th rowspan="2"></th> <th rowspan="2">Explanation</th> <th colspan="2">A</th> </tr> <tr> <th>ON</th> <th></th> </tr> </thead> <tbody> <tr> <td>B0</td> <td>ON to automatically return to the welding start position when welding has finished. [Note] The fillet welding in copying operations causes a deviation with respect to the original position.</td> <td>1</td> <td>B0</td> </tr> <tr> <td>B1</td> <td>Processing when operation is stopped by the STOP switch during tack welding OFF : Start tack operation from the start ON : Continue tack operation from the point where it stopped Note that welding is performed from the next tack, not the portion where the stop occurred during welding.</td> <td>2</td> <td>B1</td> </tr> <tr> <td>B2</td> <td>Tack welding idling distance extension function OFF : Extended only while the arc selection switch is ON, extension stopped when it is OFF ON: Extension started the first time the arc selection switch is set to ON, extension stopped the second time it is set to ON (self-latching)</td> <td>4</td> <td>B2</td> </tr> </tbody> </table>		Explanation	A		ON		B0	ON to automatically return to the welding start position when welding has finished. [Note] The fillet welding in copying operations causes a deviation with respect to the original position.	1	B0	B1	Processing when operation is stopped by the STOP switch during tack welding OFF : Start tack operation from the start ON : Continue tack operation from the point where it stopped Note that welding is performed from the next tack, not the portion where the stop occurred during welding.	2	B1	B2	Tack welding idling distance extension function OFF : Extended only while the arc selection switch is ON, extension stopped when it is OFF ON: Extension started the first time the arc selection switch is set to ON, extension stopped the second time it is set to ON (self-latching)	4	B2
	Explanation			A															
		ON																	
B0	ON to automatically return to the welding start position when welding has finished. [Note] The fillet welding in copying operations causes a deviation with respect to the original position.	1	B0																
B1	Processing when operation is stopped by the STOP switch during tack welding OFF : Start tack operation from the start ON : Continue tack operation from the point where it stopped Note that welding is performed from the next tack, not the portion where the stop occurred during welding.	2	B1																
B2	Tack welding idling distance extension function OFF : Extended only while the arc selection switch is ON, extension stopped when it is OFF ON: Extension started the first time the arc selection switch is set to ON, extension stopped the second time it is set to ON (self-latching)	4	B2																
	<p>Arc stability waiting time settings Setting range : 0~10.0s Factory default : 0s ※ It can be also set in ARC WAIT OF SELECT SWICTH.</p>																		
	<p>Torch Switch ON Output Time Setting (Crater Filling) Setting range :-0.1~1.0s Factory default : 0 Set the ON time for torch switch output to the welding power source when welding starts.</p> <ul style="list-style-type: none"> • If the welding power source setting is self-latching OFF (crater filling not supported), set this parameter to 0. • Set this value to between 0.4 and 1.0 if the power supply setting is self-latching (crater filling supported). • If the value above is set and the arc is frequently interrupted, set the value to -0.1. In this case, the signal will remain in the ON state up until the arc stop timing. However, since the specifications of some welding power sources do not support the setting of -0.1, set the value to 1.0 and adjust. <p>※The welding current during the welding return waiting time varies depending on the crater filling (self-latching) ON/OFF setting.</p> <table border="1"> <tbody> <tr> <td>crater (self-latching)"ON"</td> <td>crater(self-latching)"OFF"</td> </tr> <tr> <td>Welding with crater current</td> <td>Welding with main current</td> </tr> </tbody> </table>	crater (self-latching)"ON"	crater(self-latching)"OFF"	Welding with crater current	Welding with main current														
crater (self-latching)"ON"	crater(self-latching)"OFF"																		
Welding with crater current	Welding with main current																		

※Precautions on Use

Always match the setting of the crater (self-holding) on the welding power supply side and the carriage side

Please set the crater (self-holding) switch of the welding power supply according to the table below so that the settings match.

Please set in "parameter setup mode No.0003" the setting method of the truck side.

Welding power supply side		carriage side
crater (self-latching) "ON"	←→	-0.1 or 0.4~1.0
	match	
crater (self-latching) "OFF"	←→	



CAUTION

If the settings do not agree, the welding operation may not proceed as set. Be sure to make the crater filling (self-latching) settings agree.



Welding return waiting time setting (It shows welded time at stop state while ARC is ON after completion of welding)

Setting range : 0~999.9s

Factory default : 0s

This mode is selected to set welding return waiting time at the time of continuous travelling mode and TACK/STITCH travelling mode.

It displays welding return waiting time value on the digital meter.

※The welding current during the welding return waiting time varies depending on the crater filling (self-latching) ON/OFF setting.

crater (self-latching) "ON"	crater (self-latching) "OFF"
Welding with crater current	Welding with main current

※Precautions on Use

Be sure to make the crater filling (self-latching) setting at the welding power source and that at the carriage agree.

Set the crater filling (self-latching) switch of the welding power source according to the following table.











Please set in "parameter setup mode No.0003" the setting method of the truck side.

Welding power supply side		carriage side
crater (self-holding) "ON"	←→	-0.1 or 0.4~1.0
	match	
crater (self-holding) "OFF"	←→	





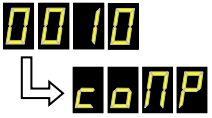
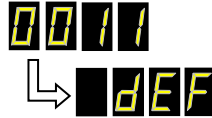
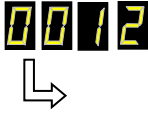
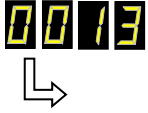

CAUTION

If the settings do not agree, the welding operation may not proceed as set. Be sure to make the crater filling (self-latching) settings agree.

	<p>Welding return distance settings(It shows length of the portion to be weld in the opposite direction while Arc is ON after welding completion)</p> <p>Setting range : 0~999.9mm 0~39.4inch Factory default : 0mm 0inch This mode is selected to set welding return distance at the time of continuous travelling mode and TACK/STITCH travelling mode. It operates after completion of welding return waiting time. It operates after completion of welding distance at welding return waiting time as 0s. It displays welding return distance value on digital meter. ※The welding current during the welding return waiting time varies depending on the crater filling (self-latching) ON/OFF setting.</p> <table border="1" data-bbox="472 524 1222 629"> <tr> <td>crater (self-holding)"ON"</td> <td>crater (self-holding)"OFF"</td> </tr> <tr> <td>Welding with crater current</td> <td>Welding with main current</td> </tr> </table> <p>※Precautions on Use</p> <p>Be sure to make the crater filling (self-latching) setting at the welding power source and that at the carriage agree Set the crater filling (self-latching) switch of the welding power source according to the following table. Please set in "parameter setup mode No.0003" the setting method of the truck side.</p> <table border="1" data-bbox="472 869 1342 1070"> <tr> <td>Welding power supply side</td> <td></td> <td>carriage side</td> </tr> <tr> <td>crater (self-holding) "ON"</td> <td>↔</td> <td>-0.1 or 0.4~1.0</td> </tr> <tr> <td></td> <td>match</td> <td></td> </tr> <tr> <td>crater (self-holding) "OFF"</td> <td>↔</td> <td></td> </tr> </table> <table border="1" data-bbox="472 1099 1342 1211"> <tr> <td style="text-align: center;"> CAUTION</td> <td>If the settings are not met, the welding operation may not be set according to the setting. Please use to match the crater (self-holding) setting.</td> </tr> </table>	crater (self-holding)"ON"	crater (self-holding)"OFF"	Welding with crater current	Welding with main current	Welding power supply side		carriage side	crater (self-holding) "ON"	↔	-0.1 or 0.4~1.0		match		crater (self-holding) "OFF"	↔		 CAUTION	If the settings are not met, the welding operation may not be set according to the setting. Please use to match the crater (self-holding) setting.
crater (self-holding)"ON"	crater (self-holding)"OFF"																		
Welding with crater current	Welding with main current																		
Welding power supply side		carriage side																	
crater (self-holding) "ON"	↔	-0.1 or 0.4~1.0																	
	match																		
crater (self-holding) "OFF"	↔																		
 CAUTION	If the settings are not met, the welding operation may not be set according to the setting. Please use to match the crater (self-holding) setting.																		
	<p>Welding return speed settings(It shows travelling speed at the time of welding return distance)</p> <p>Setting range : 50~1500mm/min 2.0~59.0inch/min Factory default:200mm/min 7.9inch/min This mode is selected to set welding return travelling speed at the time of continuous travelling mode and TACK/STITCH travelling mode. It displays welding return speed value on digital meter.</p>																		
	<p>Welding frequency settings</p> <p>Setting range : 0~999time Factory default : 0time It is welding frequency at the time of TACK/STITCH travelling mode. It displays welding frequency on digital meter. If welding frequency is set to 0, it continues with TACK/STITCH travelling till START/STOP button or Limit switch is pressed.</p>																		
	<p>Torch switch signal minimum time setting</p> <p>Setting range : 0.4~1.5s Factory default : 0.7s Sets the time to guarantee the ON/OFF state of the torch switch. Reducing this value may mean that the welding power source is unable to receive a signal, so care is required.</p>																		
	<p>Speed, Position Display Unit, Inch Setting</p> <p> : Metric  : Inch</p> <p>The displayed set value of speed and distance can be switched in metric and inches. Refer to "switch over method of metric and inch" for method to switch. After setting this parameter, switch the power off and back on.</p>																		

	※ The factory default is the metric specifications.
	Speed and Movement Position Correction Setting range : 50~200% Factory default : 100% Sets the value for correcting the actual speed with respect to the speed indicated at the digital display. Actual speed = speed displayed × [This parameter value]%
	Not used
	Not used
	Not used

6.2.4 Metric, Inch switch over method

1. Turn ON the electric supply.
2. Select "PAM" in selection switch and turn ON the START/STOP switch for once.
3. Turn the DATA DIAL and select , then turn ON START/STOP switch for once.
4. Select  or  and then turn ON the START/STOP switch for once.
 : Metric specification (mm)
 : Inch specification (inch)



5. Turn OFF the electric supply.
6. Turn ON electric supply again.
7. Turn OFF electric supply after display of speed.
8. Turn ON electric supply again(Changing over completion)

- ※ Initial setting is Metric specification.
- ※ While using in Inch specification, kindly change it to Inch specification by above mentioned operation while changing internal board.
- ※ Kindly keep interval between turning ON/OFF of electric supply for more than 2 seconds.
- ※ Kindly carry out verification by traveling speed display after completion of changing over.
 (10~1500mm specification, 2.0~59.0 Inch specification)

6.2.5 Operation Pattern Diagram

Example 1) Weaving tack/stitch welding parameter setting

Welding distance	70mm / 2.76inch
Welding return distance	30mm / 1.18inch
Sky transmission distance	40mm / 1.57inch
Welding return waiting time	1sec
Arc stability time	1sec

Operation sequence	Movement
A	 Welding movement
B	 Welding return distance
C	 preliminary feeding distance

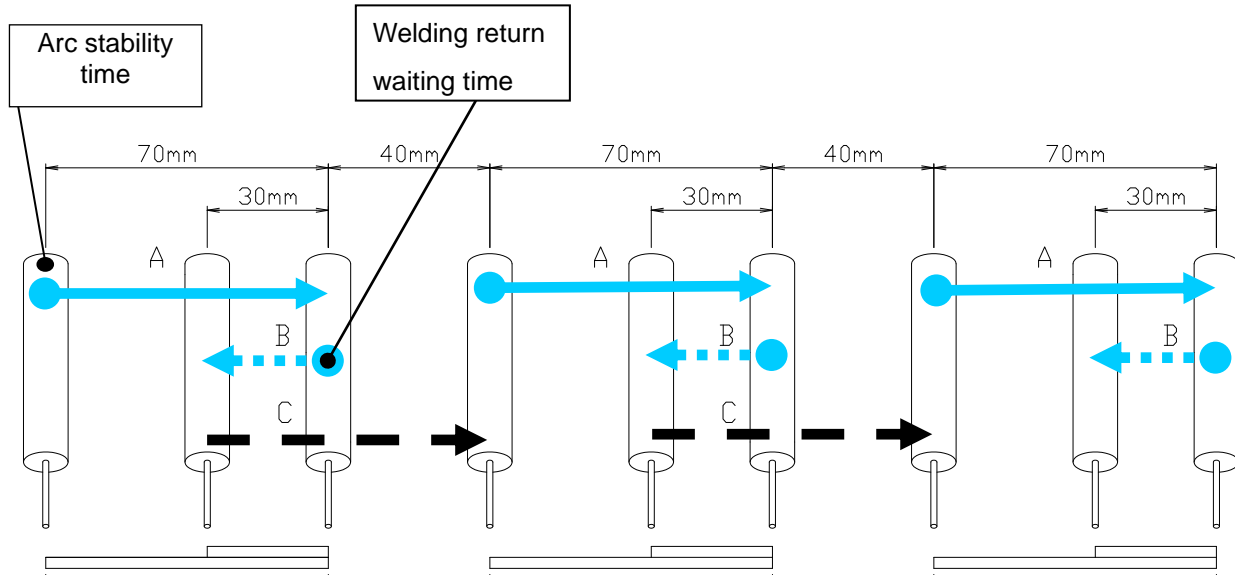

※In the weaving tack driving  at the time of the operation, the weaving operation will be done. At the time of sky transmission distance, the weaving operation is not done.

※Stop work by START / STOP button or limit switch, the running and welding can be stopped.

※Only when the limit switch is pressed during welding movement, welding move at the time the limit switch is pressed. Motion is finished and moves to welding return movement.

Driving and welding will stop at the time of the welding return operation is completed.

※If the START/STOP button has been pressed, in any action at the time the START/STOP button has been pressed Driving and welding stops.

※If you stop in the START / STOP button or limit switch, weaving unit will stop back to always origin position.

Further, "Welding distance", "Preliminary feeding distance", "Welding return distance" can be changed by operating "Arc changing over switch" during weaving tack/stitch welding operation. Kindly operate by referring to below mentioned settings while changing distance during weaving tack/stitch welding operation.

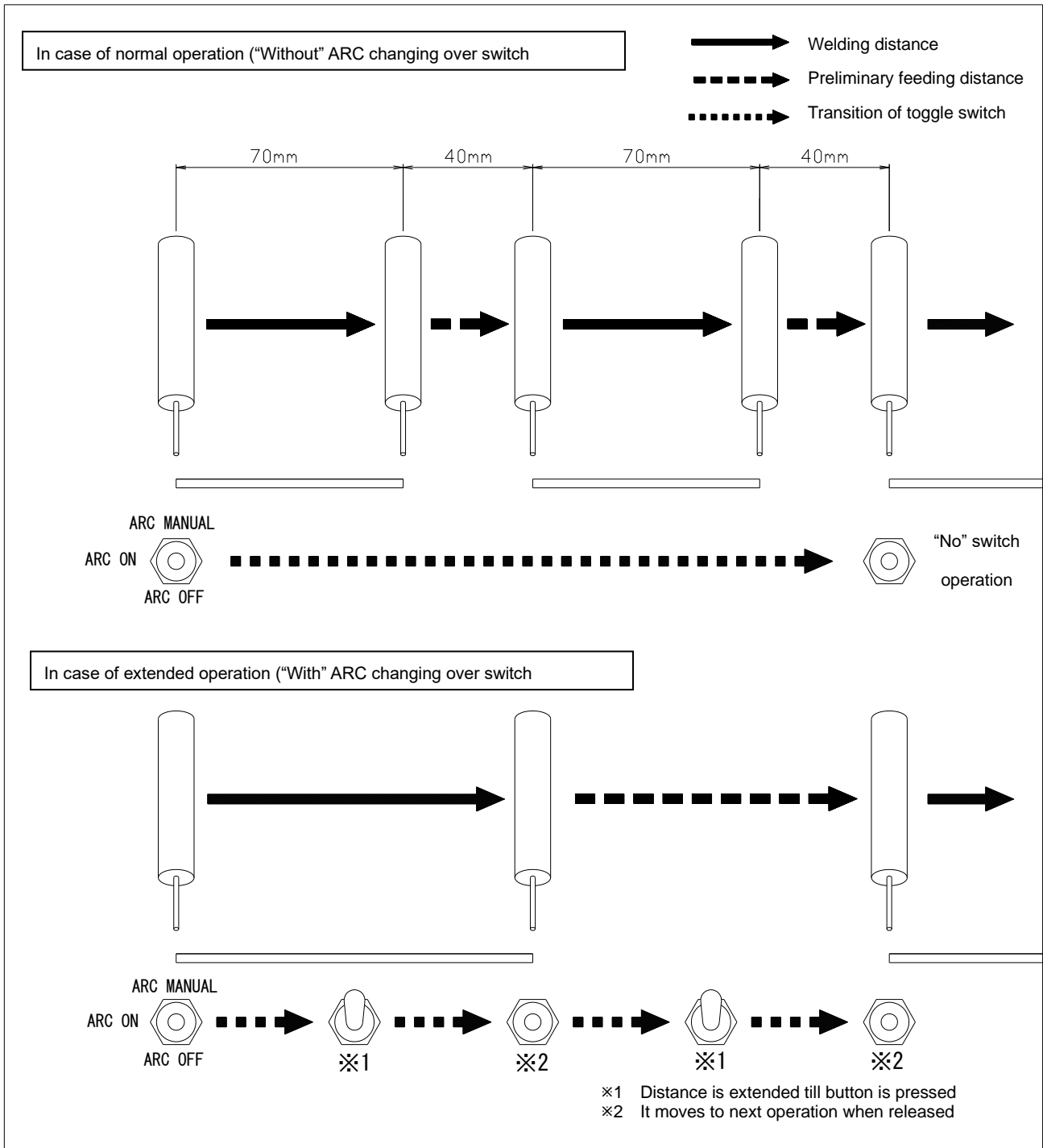

6.2.6 Weaving movement time chart

The weaving movement at the time of the weaving welding becomes like the following time chart.

Example1) Parameter settings

Central torch stop time 0sec

Left torch stop time 0sec

Right torch stop time 0sec

Weaving swing width 10mm / 0.39inch

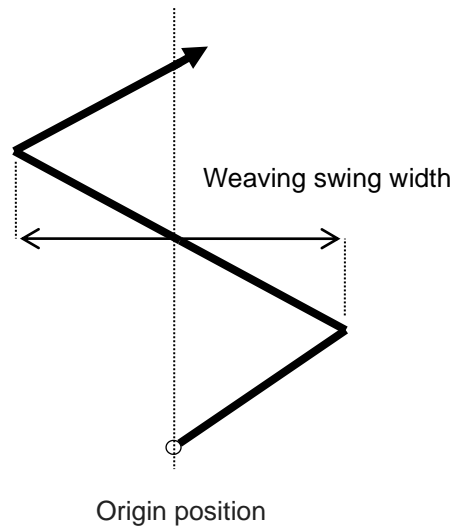

Example2) Parameter settings

Central torch stop time 1.0sec

Left torch stop time 1.0sec

Right torch stop time 1.0sec

Weaving swing width 10mm / 0.39inch

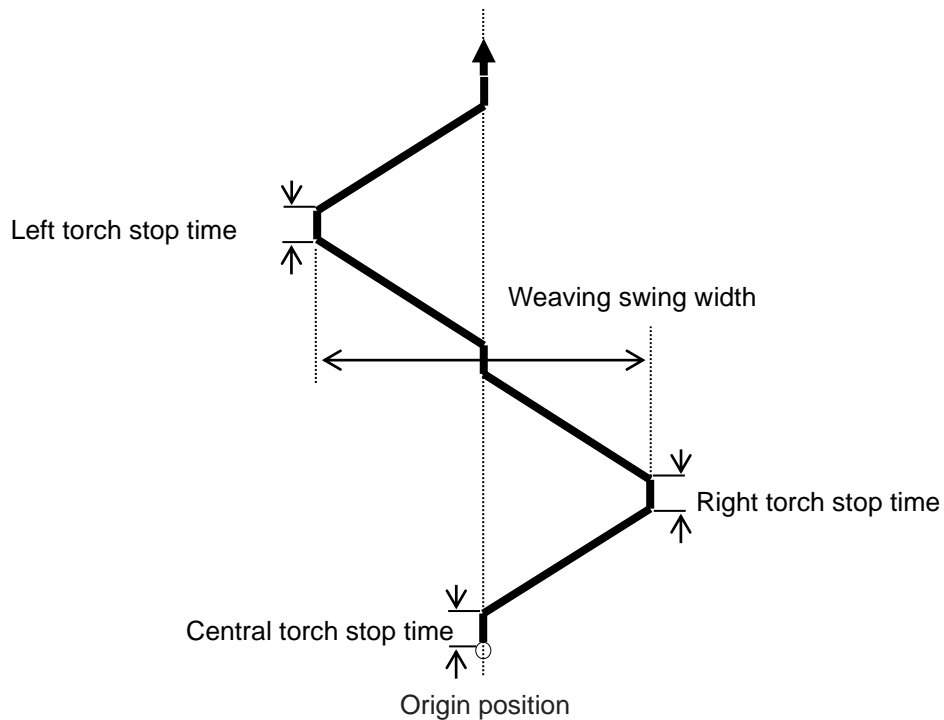

※Weaving swing speed, is the speed at the position 100 mm or 3.94 inch away from the center of rotation.

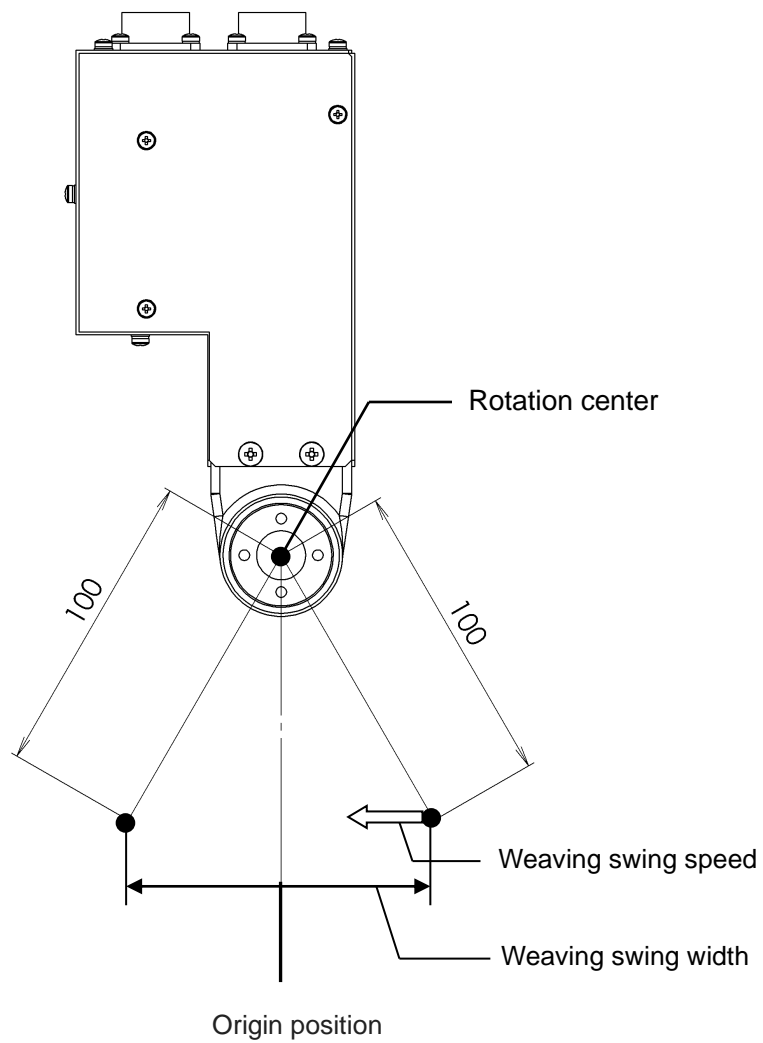

6.2.7 tack/stitch running motion Time chart

Crater (self-holding)"OFF" setting

- A Arc stability waiting time 0s
- B Welding return waiting time 0s
- C Welding return distance 0mm(0inch)

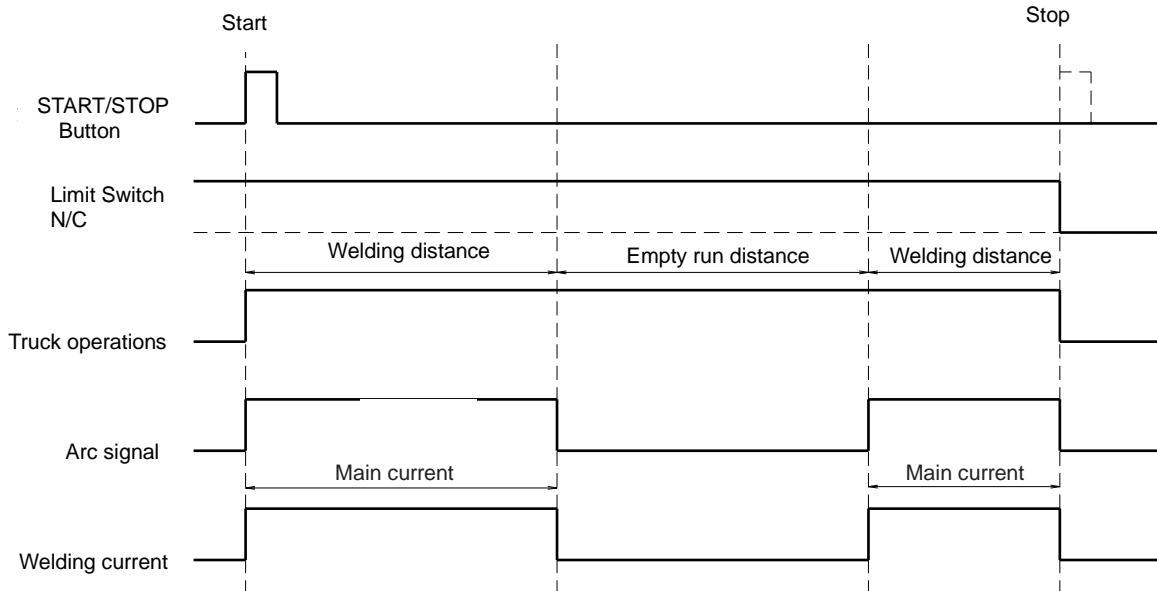

Crater (self-holding)"ON" setting

- A Arc stability waiting time 0s
- B Welding return waiting time 0s
- C Welding return distance 0mm(0inch)

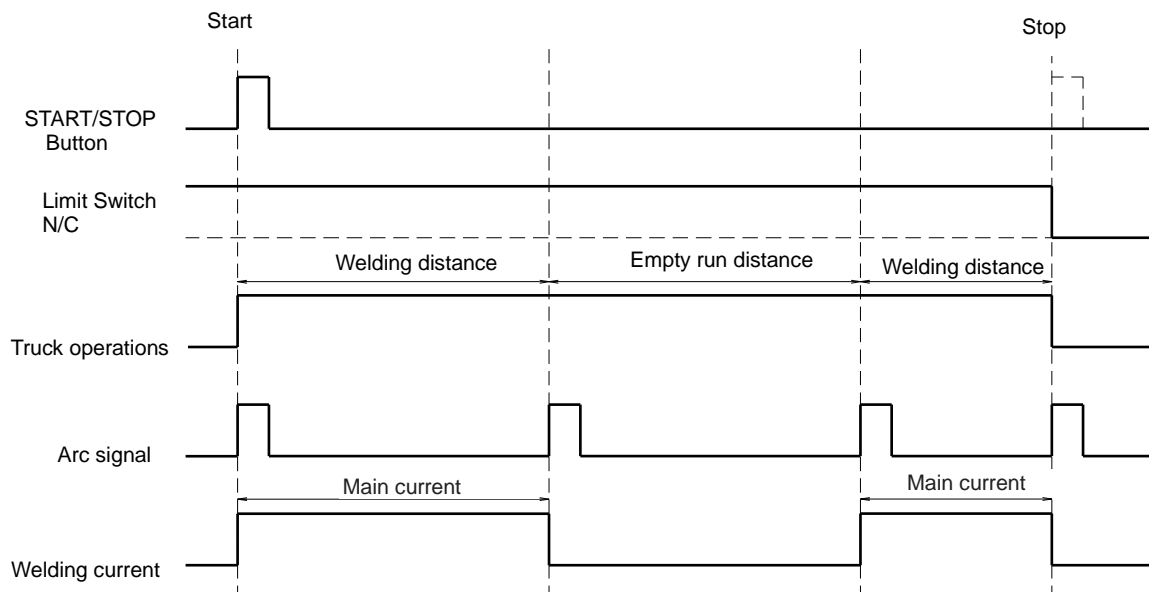

Crater (self-holding)"OFF" setting

- A Arc stability waiting time 1.0s
- B Welding return waiting time 1.0s
- C Welding return distance 5mm(0.19inch)

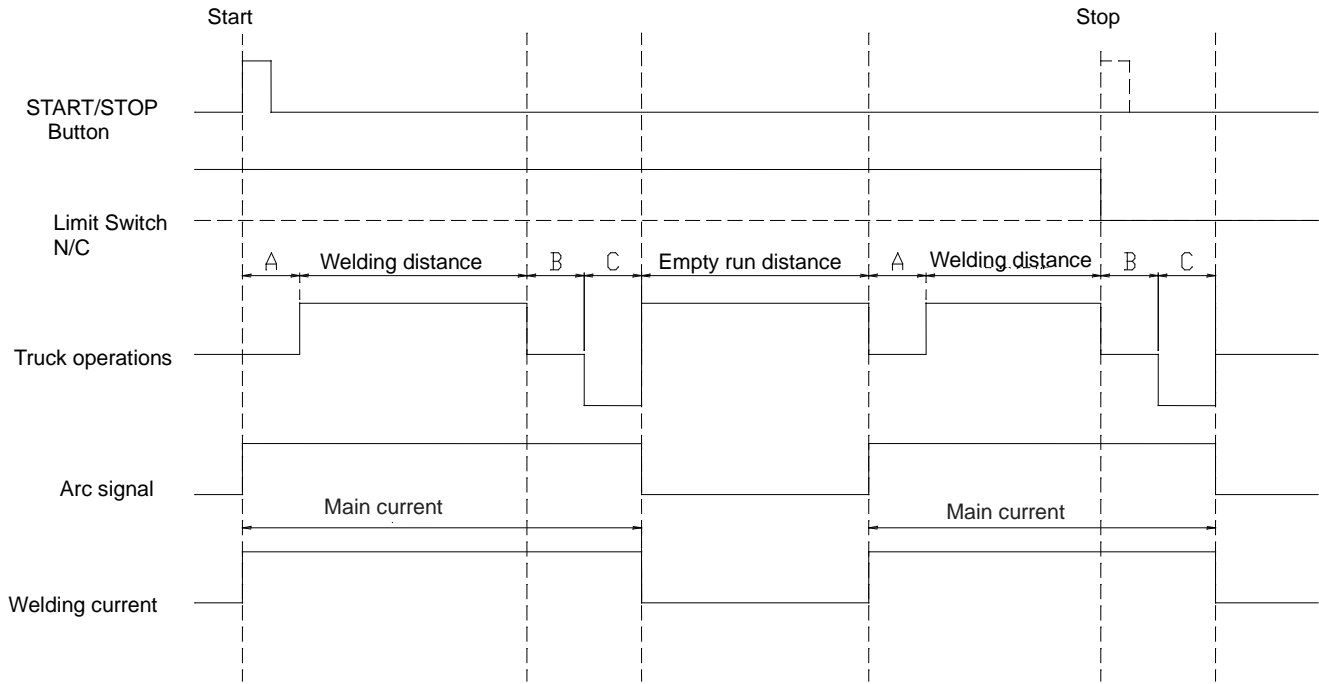



Crater (self-holding)"ON" setting

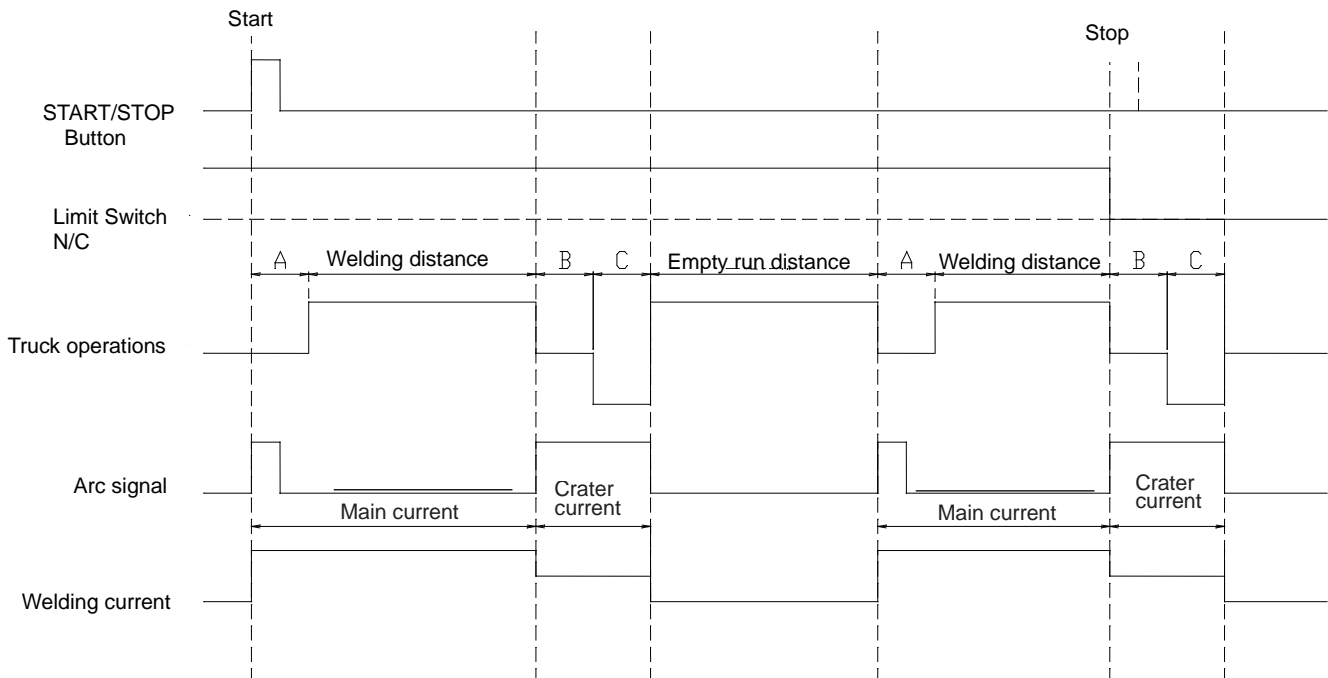

- A Arc stability waiting time 1.0s
- B Welding return waiting time 1.0s
- C Welding return distance 5mm(0.19inch)







6.2.8 Welding preparation and welding procedure

 WARNING	<p>Kindly take care about following things to avoid getting an electric shock.</p>
	<ul style="list-style-type: none"> ● Kindly remove input plug from outlet while checking, dis-assembling or repairing and turn OFF the control source while leaving. If it is necessary to carry out checking in the energized state, professional engineer having enough knowledge and skill about electric handling should go since there is risk of short circuit, getting electric shock.
<ul style="list-style-type: none"> ● Do not use welding equipment without case or cover. ● Kindly use power outlet with earth pin outlet since input plug has earth pin. It is connected to main body of carriage in operation panel. ● Kindly use input voltage within $\pm 10\%$ for power supply input to input plug. There is risk of short circuit due to failure of printed board on operation panel. ● In case of crack in insulation cover of power cable and torch cable, do not expose it to high temperature. There is risk of short circuit due to tearing of insulation covering. ● Kindly weld below the rated current and usage rate of torch to prevent dielectric breakdown due to overheating. ● Kindly place power cable and torch cable in proper manner so that they are not stretched or pulled. There is possibility of breakage of insulation by damaging holding part and connector part due to pulling. ● Do not throw or drop main body of carriage. There is risk of damaging insulation by breaking. ● While connecting to power cable plug to main body, kindly connect after verifying that foreign object is not touching to connector of main body, power cable plug. There is risk of connector erosion due to short circuit by foreign object. 	

 WARNING	<p>Strictly observe the following to prevent burns.</p>
<ul style="list-style-type: none"> ■ Never directly touch the torch nozzle, tip, orifice, insulation cylinder, and the surface of the carriage which are very hot right after welding. 	

 WARNING	<p>Kindly take care about following things to avoid falling off of carriage</p>
	<ul style="list-style-type: none"> ● Do not lift the carriage by holding its Handle. There is risk of falling off carriage while holding carriage by handle, if there is shock impact at carriage or if mounting screw of handle is loose.

 WARNING	<p>Please observe that the following.</p> <p>Be sure to make the crater filling (self-latching) setting at the welding power source and that at the carriage agree Set the crater filling (self-latching) switch of the welding power source according to the following table. Please set in “parameter setup mode No.0003” the setting method of the truck side.</p> <table border="1" style="width: 100%; border-collapse: collapse;"> <thead> <tr> <th style="width: 50%; text-align: center;">Welding power supply side</th> <th style="width: 50%; text-align: center;">carriage side</th> </tr> </thead> <tbody> <tr> <td style="text-align: center;">crater (self- latching) "ON"</td> <td style="text-align: center;">-0.1 or 0.4~1.0</td> </tr> <tr> <td colspan="2" style="text-align: center;"> <div style="display: flex; justify-content: center; align-items: center; gap: 20px;"> <div style="border: 1px solid black; padding: 2px 5px;">match</div> <div style="font-size: 2em;">↔</div> </div> </td> </tr> <tr> <td style="text-align: center;">crater (self- latching) "OFF"</td> <td style="text-align: center;">  </td> </tr> </tbody> </table>	Welding power supply side	carriage side	crater (self- latching) "ON"	-0.1 or 0.4~1.0	<div style="display: flex; justify-content: center; align-items: center; gap: 20px;"> <div style="border: 1px solid black; padding: 2px 5px;">match</div> <div style="font-size: 2em;">↔</div> </div>		crater (self- latching) "OFF"	
Welding power supply side	carriage side								
crater (self- latching) "ON"	-0.1 or 0.4~1.0								
<div style="display: flex; justify-content: center; align-items: center; gap: 20px;"> <div style="border: 1px solid black; padding: 2px 5px;">match</div> <div style="font-size: 2em;">↔</div> </div>									
crater (self- latching) "OFF"									
 CAUTION	<p>If the settings do not agree, the welding operation may not proceed as set. Be sure to make the crater filling (self-latching) settings agree.</p>								

- (1) Connect power cable to Receptacle of operation unit. (By connecting power cable, it turns ON LED on Digital meter and “RDY” at the same time. It also turns ON LED of “ARC” when ARC changing over switch is on ARC ON position)
- (2) Mount the exclusive use torch on the torch holder.

 CAUTION	<p>When tightening the torch holder, use the accompanying wrench bar or other tools in an appropriate size.</p> <p>■ Improper tool can cause unexpected injury.</p>
---	--

- (3) Connect the torch to the mating wire feeder.
- (4) Turn ON the power switch of the welding power supply and insert the wire into the torch. (Insert the torch cable straightly.)

 CAUTION	<p>When inserting the wire, do not bring your head near the wire that comes out of the tip.</p> <p>■ Your eyes can be damaged.</p>
---	---

- (5) Press the tracing roller against the vertical plate, and set the carriage in the welding position
- (6) For attraction by magnet, incline the magnet lever.
- (7) Turn the handle of the slide unit assembly (UP/DOWN or FRONT/REAR) for torch position alignment.
Origin position of the torch can be adjusted by turning the DATA DIAL to fit the SELECT SWITCH according to ORG.
- (8) Select each parameter by SELECT SWITCH and set parameter value by DATA DIAL.
- (9) Match SELECT SWITCH to either of continuous travelling mode or weaving tack travelling mode settings after completion of each parameter settings.
- (10) Turn DATA DIAL and set travelling speed.
(LED of “BSY” turns ON during carriage operation and LED of “WEL” turns ON during ARC generation).

**CAUTION**

To back up the set parameters, once the power to OFF Please restart.

- Truck and WU-5R will back up the parameters OFF Then set the power during the stop.
- OFF the power during the operation result, it can not be backed up correctly Parameter.

(11) Determine the start position.

※Positioning of carriage (fine tuning) can be carried out easily by pressing Limit switch.

(12) Set welding conditions with welding power supply.

(13) Press START/STOP button, and start welding. (Arcs will be generated at the same time.)

**CAUTION**

Pay attention to the following during welding.

- Wear a welding mask, face guard, and welding protectors to protect yourself from arc light, fumes, and spatters.

(14) Finely adjust the welding conditions (current, voltage, speed, etc.) as necessary.

(15) Welding can be stopped by means of the stop switch or limit switch. (While the carriage stops, arcs stop at the same time.)

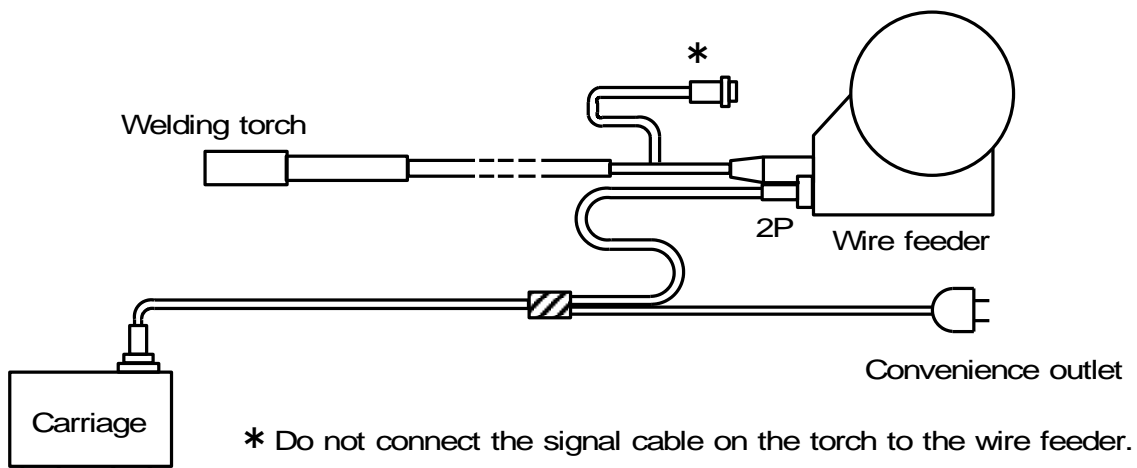

System connection diagram

6.3 TYPE-F WU-3R WEAVING HOLDER SET



Regarding the operation method and welding operation, refer to separate manual "IK-12 NEXT".

7 Operational precautions

1. Please be sure to observe the operating voltage. If it is used at other than DC24V, it may cause a malfunction.
2. Please thoroughly clean slag, spatter etc. of rotary drive part before use.
3. When long cables are necessary, take appropriate measures for the cables to prevent catching or entanglement by means of a jig crane, etc.
4. If backlash of weaving movement comes out, please change the mounting position of the torch holder by 90 degrees and install it.

8 Maintenance

For correct operation of the machine for an extended period of time without trouble, the daily maintenance is indispensable. Also, if a breakdown occurs, refer to " Trouble shooting ".

 WARNING	<p>Kindly take care about following things to avoid getting an electric shock.</p>
	<ul style="list-style-type: none"> ● Kindly remove input plug from outlet while checking, dis-assembling or repairing and turn OFF the control source while leaving. If it is necessary to carry out checking in the energized state, professional engineer having enough knowledge and skill about electric handling should go since there is risk of short circuit, getting electric shock. ● Do not use welding equipment without case or cover. ● Kindly use power outlet with earth pin outlet since input plug has earth pin. It is connected to main body of carriage in operation panel. ● Kindly use input voltage within $\pm 10\%$ for power supply input to input plug. There is risk of short circuit due to failure of printed board on operation panel. ● In case of crack in insulation cover of power cable and torch cable, do not expose it to high temperature. There is risk of short circuit due to tearing of insulation covering. ● Kindly weld below the rated current and usage rate of torch to prevent dielectric breakdown due to overheating. ● Kindly place power cable and torch cable in proper manner so that they are not stretched or pulled. There is possibility of breakage of insulation by damaging holding part and connector part due to pulling. ● Do not throw or drop main body of carriage. There is risk of damaging insulation by breaking. ● While connecting to power cable plug to main body, kindly connect after verifying that foreign object is not touching to connector of main body, power cable plug. There is risk of connector erosion due to short circuit by foreign object.

8.1 Maintenance and inspection

8.1.1 Daily inspection

- (1) Clean the nozzle and check the tip for abrasion.
- (2) Cleaning of adhering spatter etc.













8.1.2 Monthly inspection

- (1) Check cables (torch and control) for twisting or broken sheathing.
- (2) Check the switches on the operation panel for looseness or breakage, and confirm the operation of switches.
- (3) Clean the conduit liner of the torch.
- (4) Check the operation panel, switches, and controls for looseness or breakage. Check their operation.

8.2 Recommended spare parts

- (1) Switches
- (2) Printed circuit board

8.3 Trouble shooting

Defects	Cause/check position						
(1) No electric power supply	1) No power supply voltage to outlet. 2) Cable is disconnected.						
	<table border="1"> <tr> <td style="text-align: center;"></td> <td>WARNING</td> <td>Kindly take care about following things to avoid getting an electric shock.</td> </tr> <tr> <td style="text-align: center;"></td> <td></td> <td> <ul style="list-style-type: none"> ■ Since above mentioned 1) and 2) checking are to be carried out while control power supply is ON, professional engineer having enough knowledge and skill about electric handling should go to prevent risk of short circuit, getting an electric shock. </td> </tr> </table>		WARNING	Kindly take care about following things to avoid getting an electric shock.			<ul style="list-style-type: none"> ■ Since above mentioned 1) and 2) checking are to be carried out while control power supply is ON, professional engineer having enough knowledge and skill about electric handling should go to prevent risk of short circuit, getting an electric shock.
	WARNING	Kindly take care about following things to avoid getting an electric shock.					
		<ul style="list-style-type: none"> ■ Since above mentioned 1) and 2) checking are to be carried out while control power supply is ON, professional engineer having enough knowledge and skill about electric handling should go to prevent risk of short circuit, getting an electric shock. 					
(2) Even if the parameter is changed, the operation of Weaving does not change.	<table border="1"> <tr> <td style="text-align: center;"></td> <td>WARNING</td> <td>Kindly take care about following things to avoid getting an electric shock.</td> </tr> <tr> <td style="text-align: center;"></td> <td></td> <td> <ul style="list-style-type: none"> ■ Kindly carry out continuity check by tester while electric supply is turned OFF. ■ Since above mentioned 1) and 2) checking are to be carried out while control power supply is ON, professional engineer having enough knowledge and skill about electric handling should go to prevent risk of short circuit, getting an electric shock. </td> </tr> </table>		WARNING	Kindly take care about following things to avoid getting an electric shock.			<ul style="list-style-type: none"> ■ Kindly carry out continuity check by tester while electric supply is turned OFF. ■ Since above mentioned 1) and 2) checking are to be carried out while control power supply is ON, professional engineer having enough knowledge and skill about electric handling should go to prevent risk of short circuit, getting an electric shock.
		WARNING	Kindly take care about following things to avoid getting an electric shock.				
		<ul style="list-style-type: none"> ■ Kindly carry out continuity check by tester while electric supply is turned OFF. ■ Since above mentioned 1) and 2) checking are to be carried out while control power supply is ON, professional engineer having enough knowledge and skill about electric handling should go to prevent risk of short circuit, getting an electric shock. 					
	1) Defective motor 2) Defective printed board 3) Disconnection of motor encoder line						
(3) It does not weaving even if START / STOP button is pushed	1) Defective START/STOP button 2) Defective printed board						

(4) No stopping of welding and traveling of carriage even at pressing of Limit switch	1) The crater filling (self-latching) setting does not match on Welding power supply side and carriage side. 2) Defective printed board.
(5) Display of Digital meter does not changed even after turning of SELECT SWITCH	1) Defective printed board. 2) Disconnection of electric wire
(6) Numeric value of parameter does not change	1) Defective printed board. 2) Disconnection of electric wire

8.4 Warranty

This is thoroughly inspected and tested before leaving the factory, and guaranteed for 12 months from the date of purchase against defective workmanship and material. Should any trouble develop, return the complete equipment prepaid to KOIKE Sanso Kogyo Co., Ltd.
Authorized KOIKE Distributor

9 Wiring diagram

9.1 WEAVING UNIT WU-3R

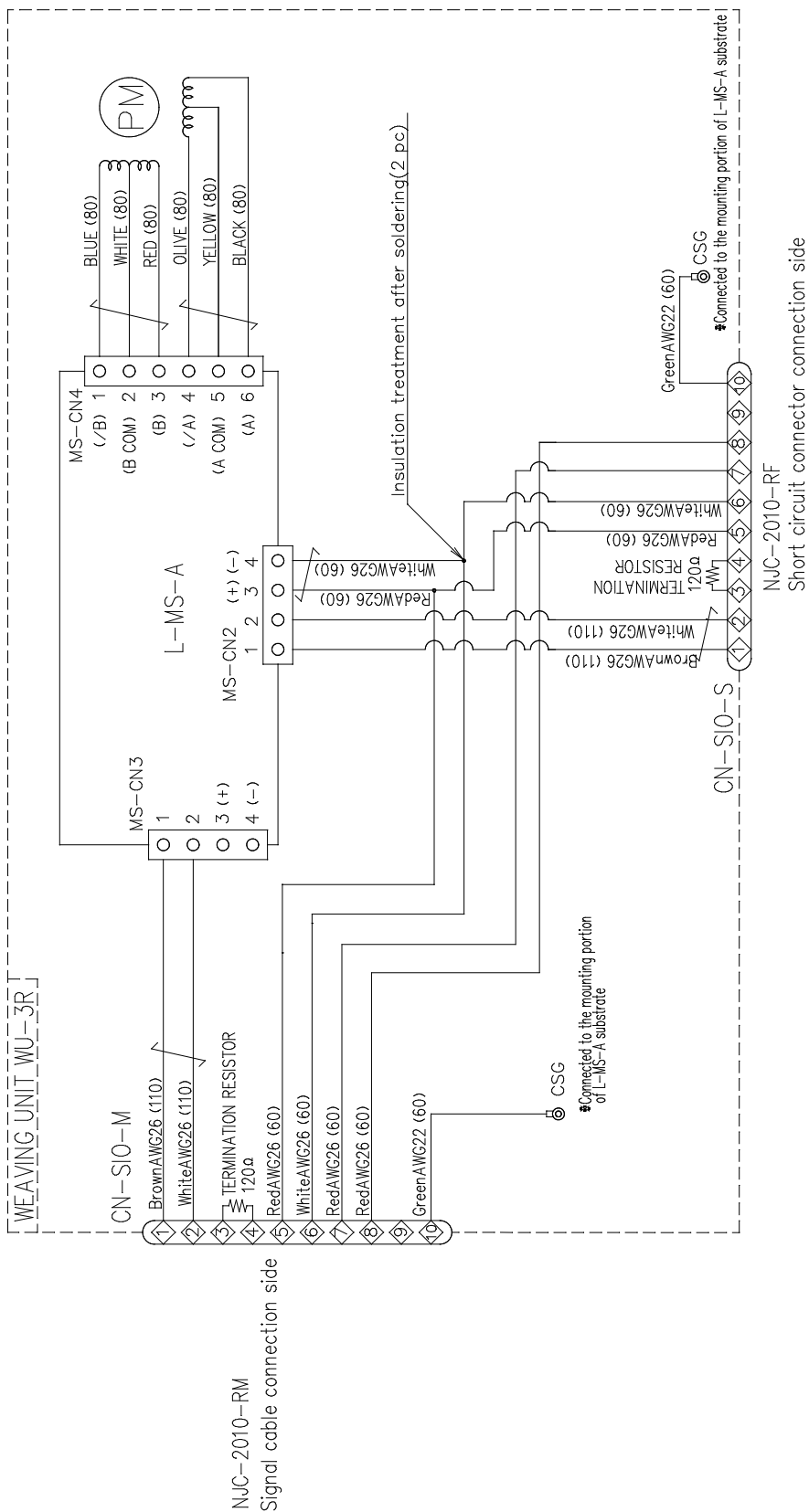

9.2 IK-12 NEXT

9.2.1 Caution (About Power Supply)

From the production batch in February 2023, we have switched the built-in switching power supply in our products from TDK Lambda to CINCON.

Manufactured By TDK Lambda



Manufactured By Cincon

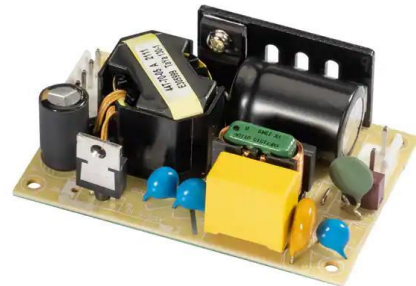

The electrical circuit diagram is divided into two types of switching power supplies: CINCON and TDK Lambda. Please compare the above photo with the switching power supply currently in use and refer to the electrical circuit diagram.

9.2.2 (TDK Lambda power supply specifications)

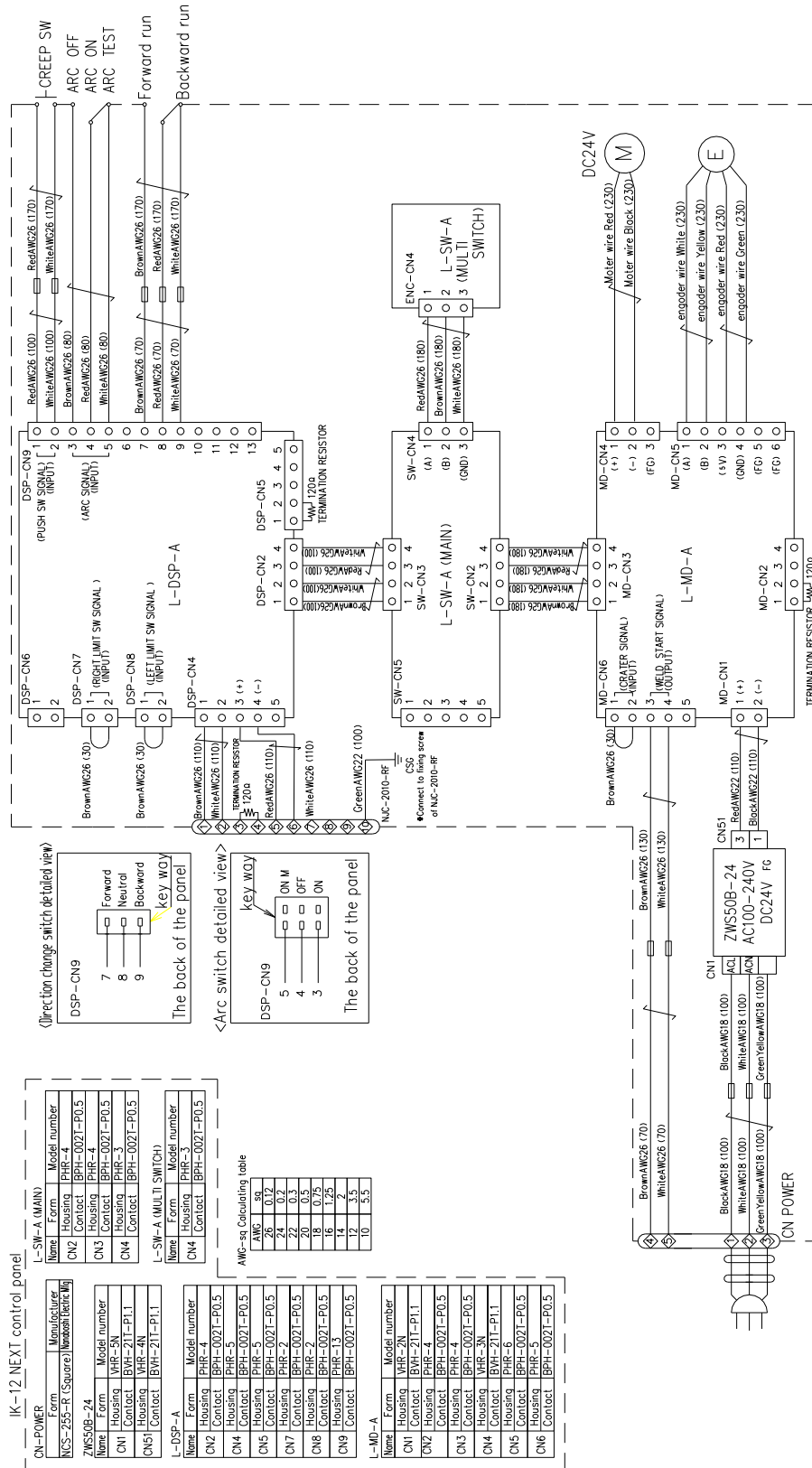

9.2.3 (CINCON power supply specifications)

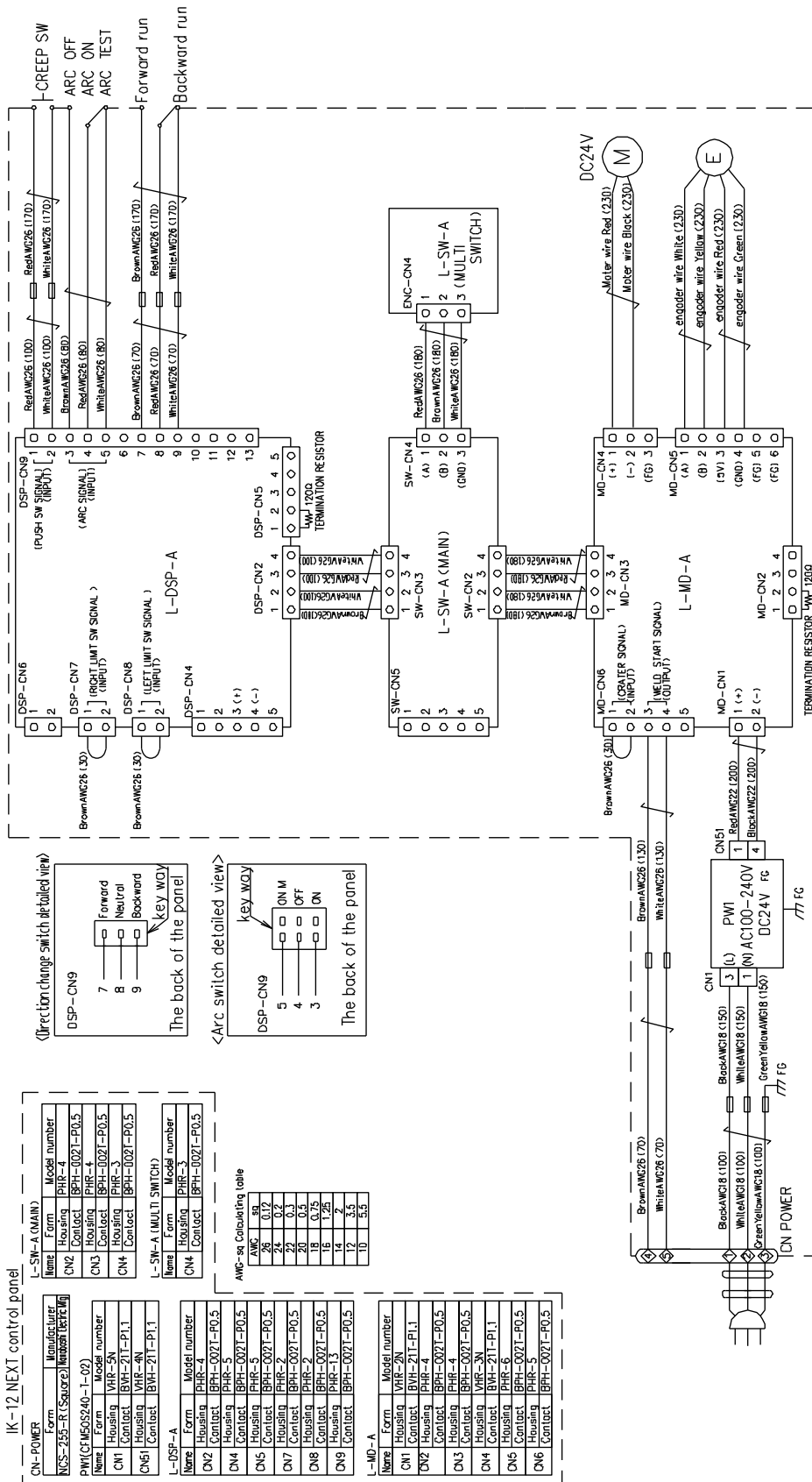

10 Assembly drawing

10.1 Torch stand mount kit

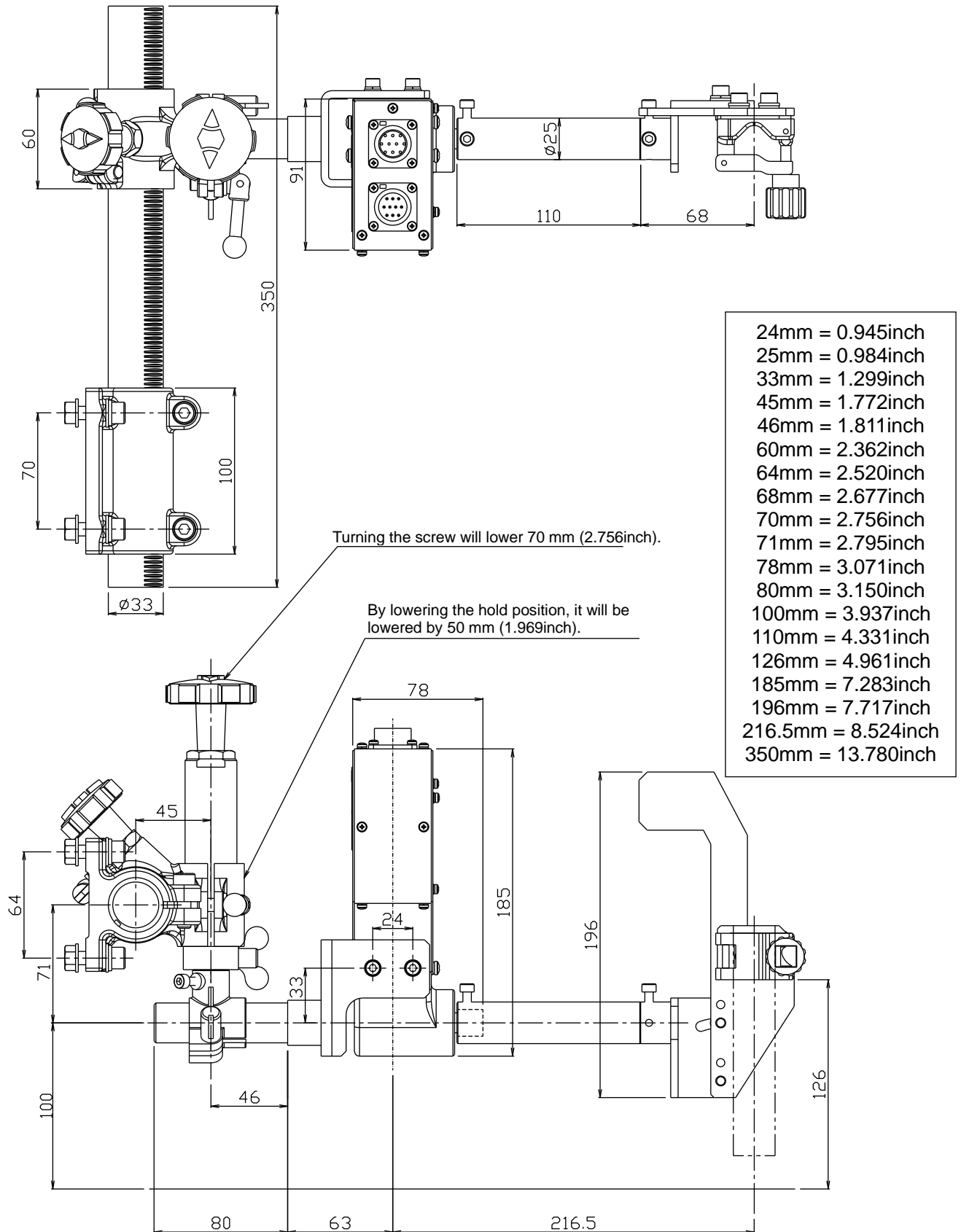

10.2 WEL-HANDY MULTI NEXT TACK mount kit

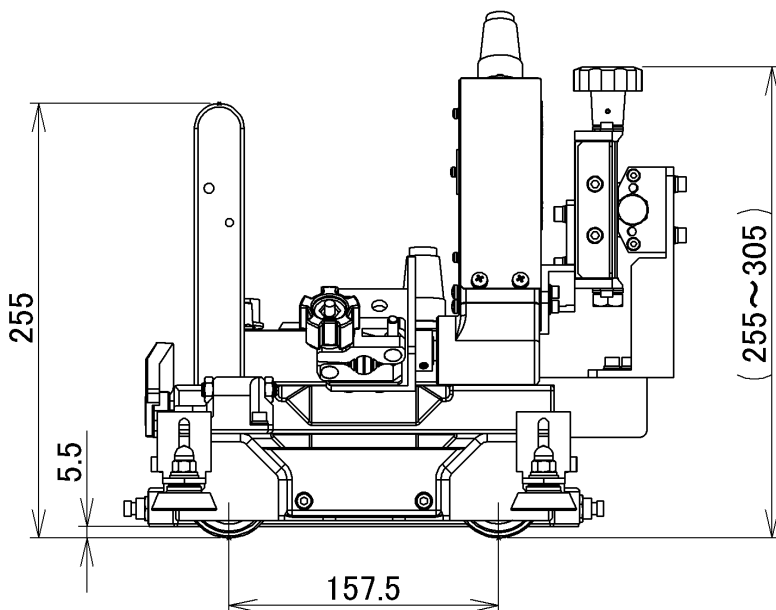
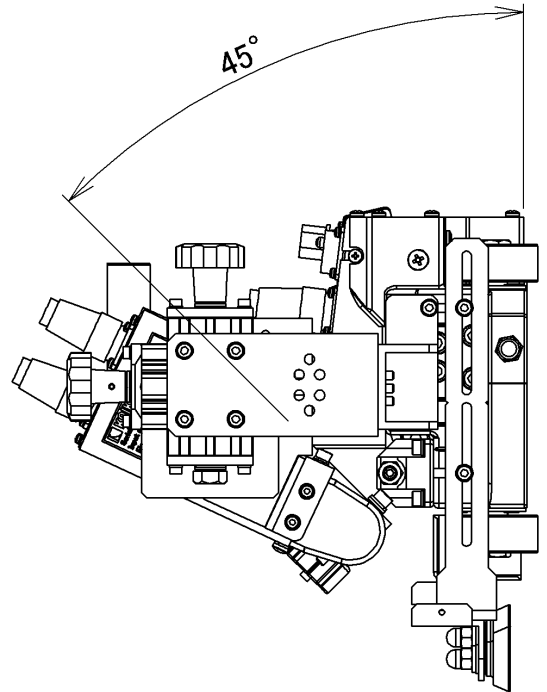
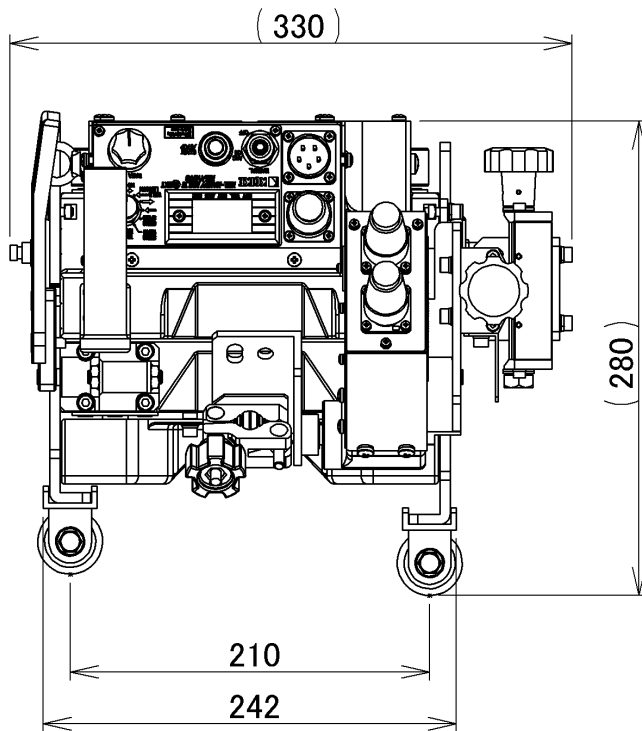

5.5mm	=	0.217inch
157.5mm	=	6.201inch
210mm	=	8.268inch
242mm	=	9.528inch
255mm	=	10.039inch
280mm	=	11.024inch
305mm	=	12.008inch
330mm	=	12.992inch

10.3 TYPE-F WU-3R WEAVING HOLDER SET

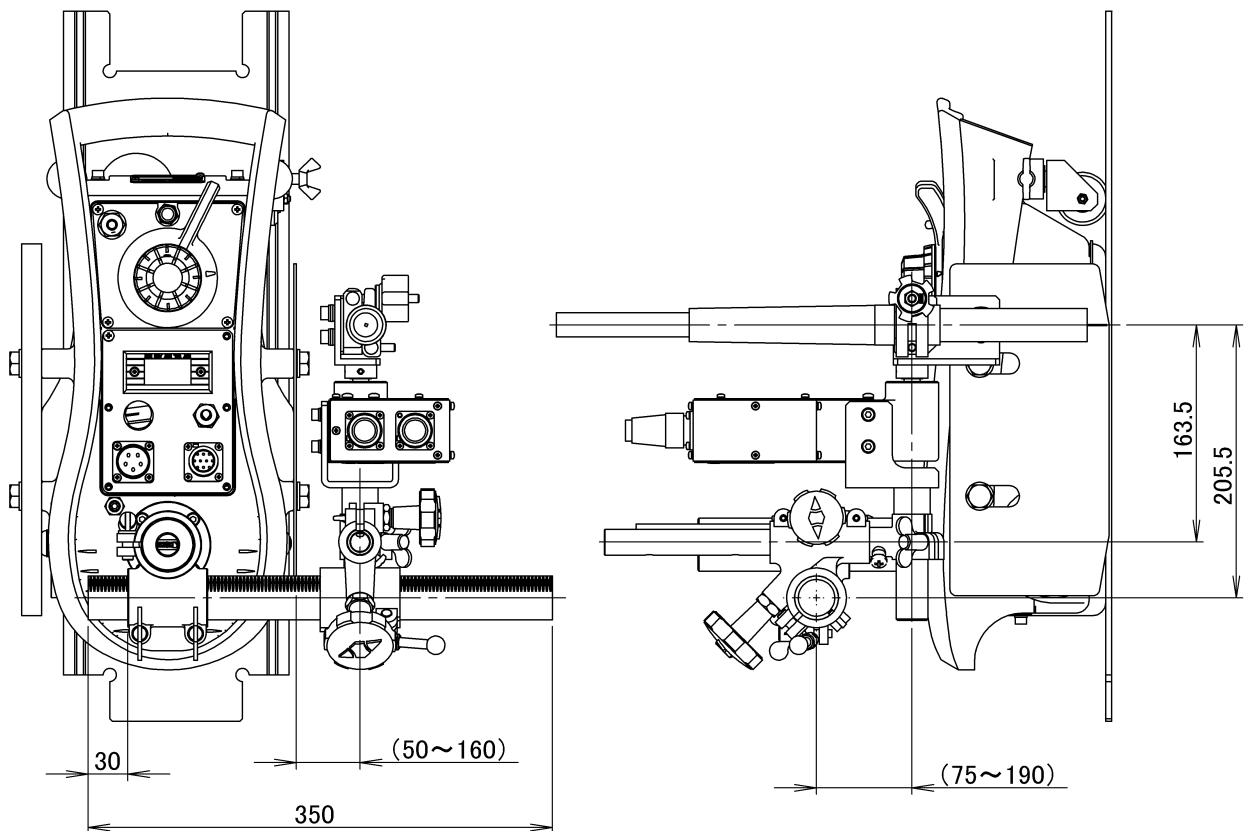

30mm	=1.18inch
50mm	=1.97inch
64.5mm	=2.54inch
75mm	=2.95inch
160mm	=6.3inch
163.5mm	=6.44inch
190mm	=7.48inch
205.5mm	=8.09inch
312mm	=12.28inch
350mm	=13.78inch

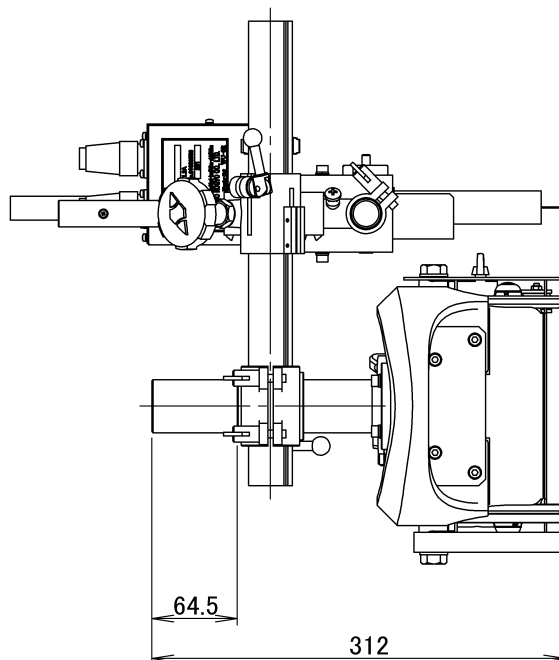

11 Parts list

11.1 Weaving unit WU-3R

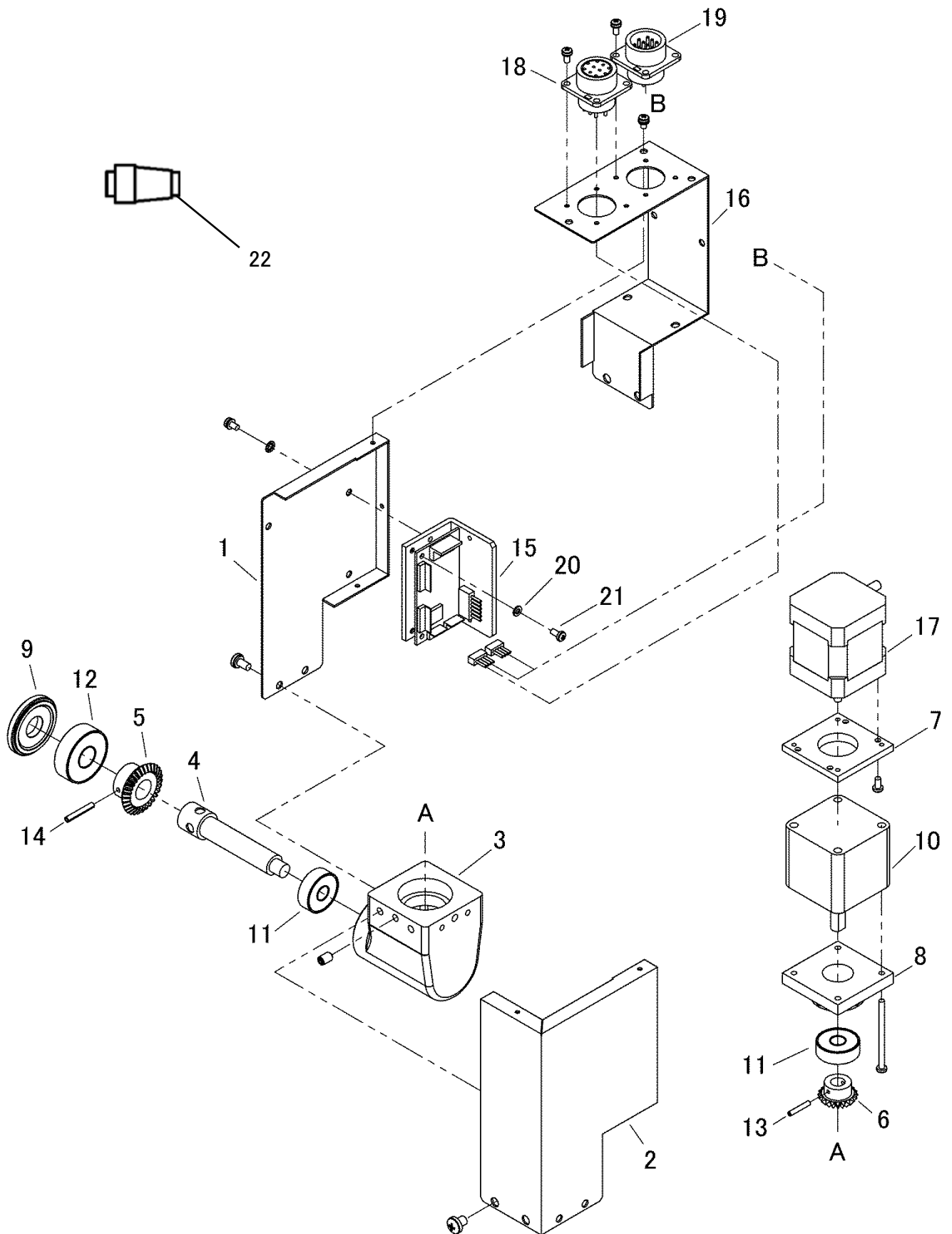

11.2 Torch stand mount kit

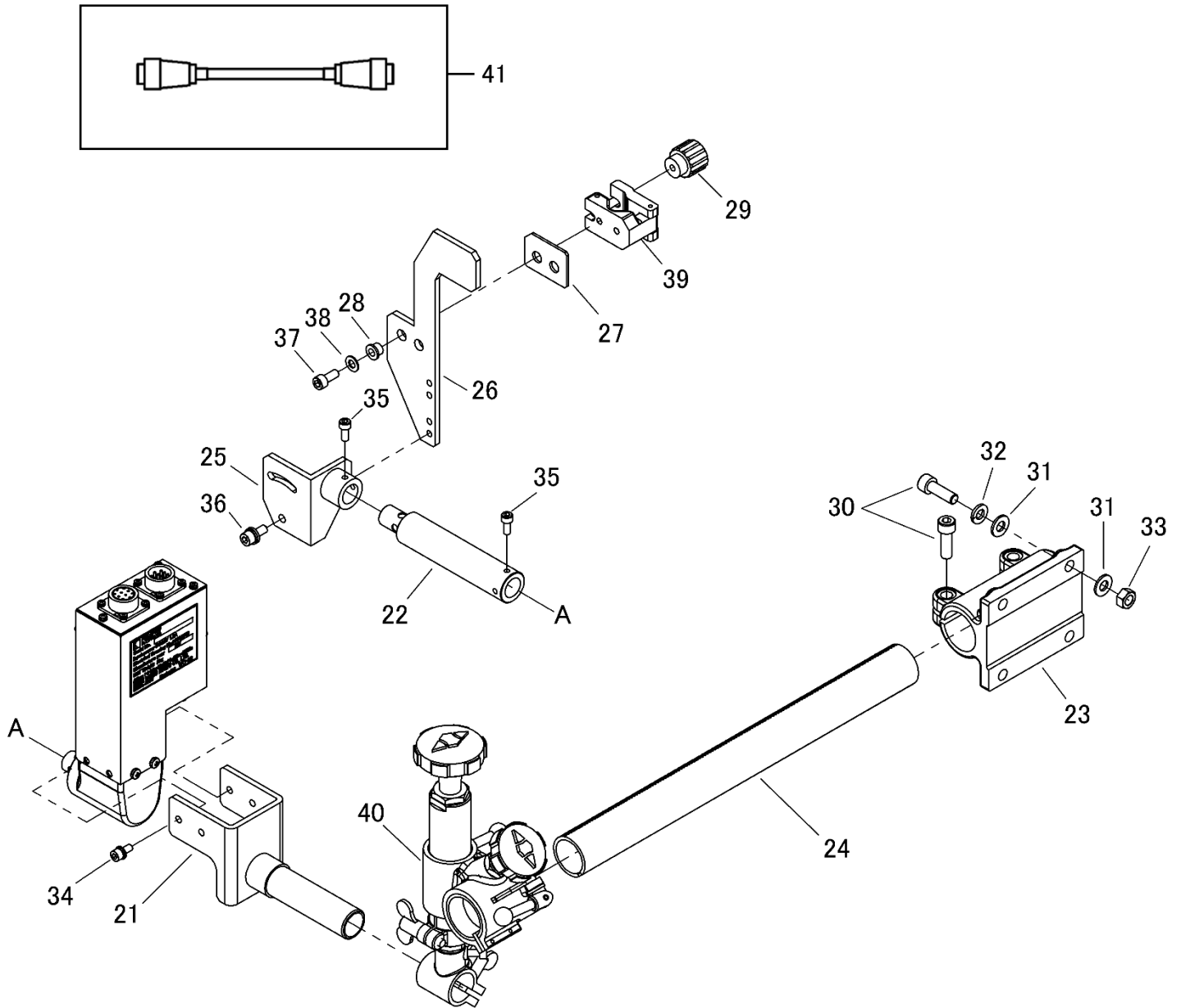

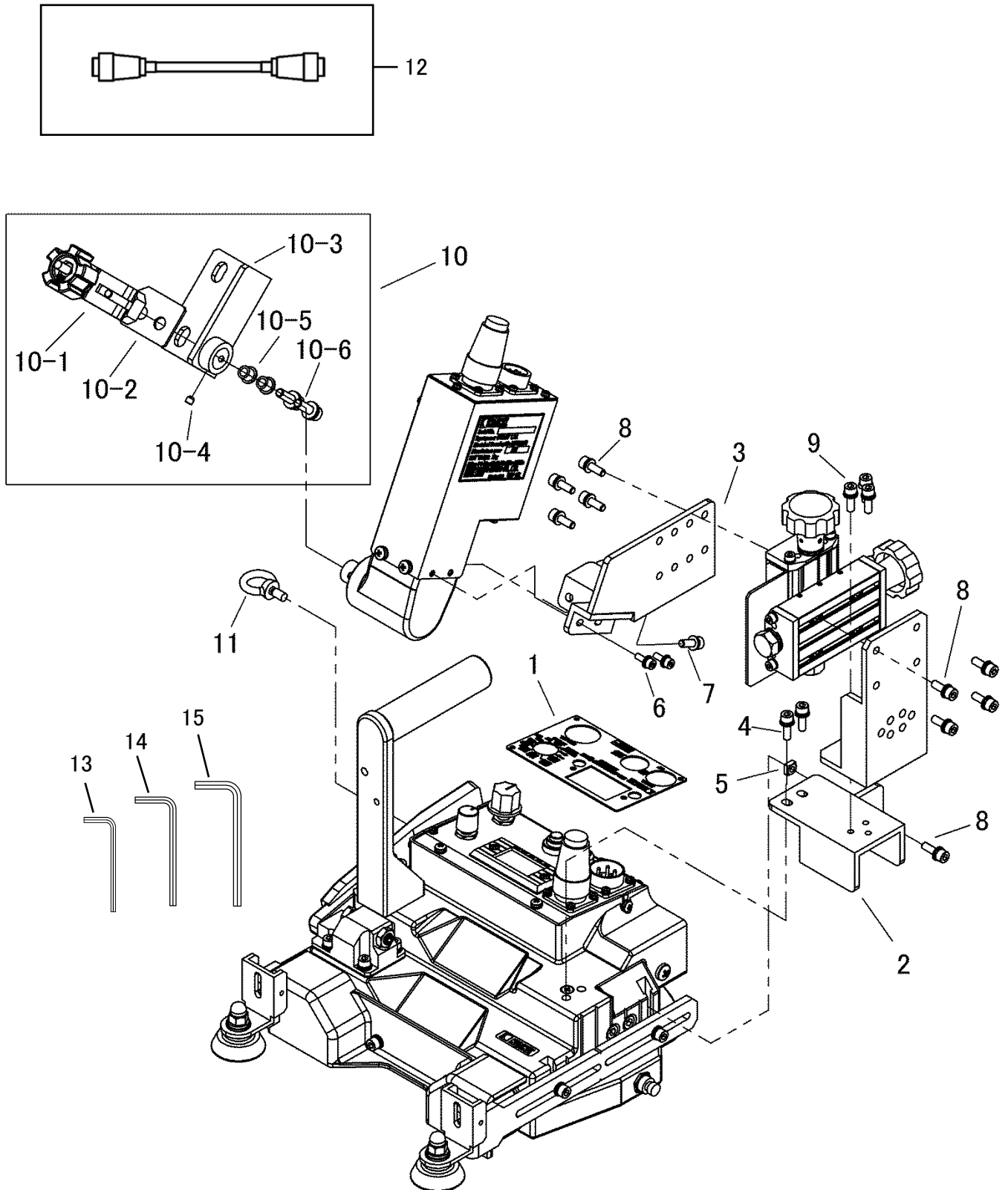
11.3 WEL-HANDY MULTI NEXT mount kit

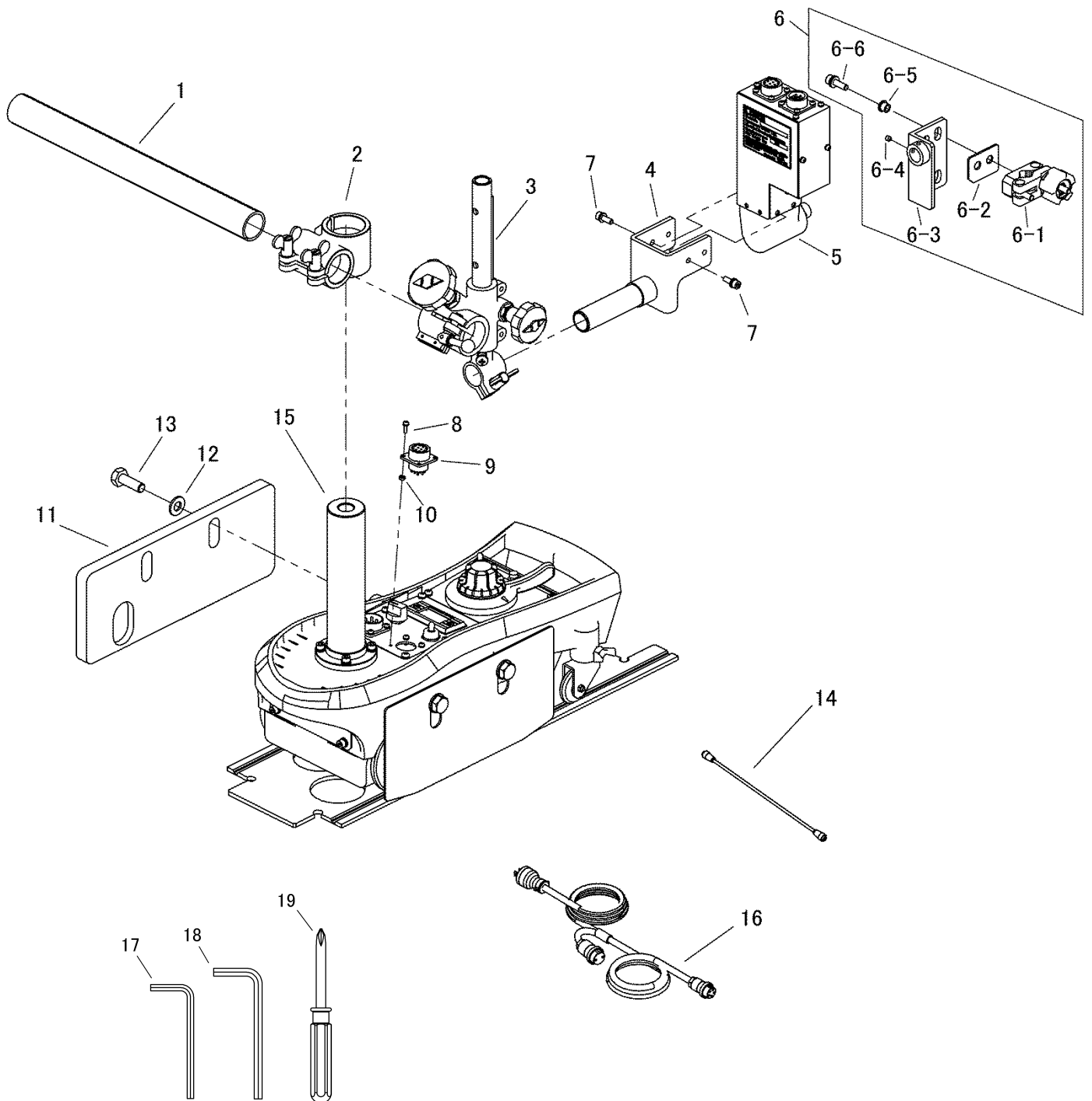
11.4 TYPE-F WU-3R WEAVING HOLDER SET

**WEAVING UNIT WU-3R
OPERATION MANUAL**

Date of issue:	Sep.2018
2nd	Dec.2018
3rd	Apr.2019
4th	May.2019
5th	May.2020
6th	Mar.2021
7th	Apr.2023
8th	Mar.2024

KOIKE SANSO KOGYO CO.,LTD.

Printed in Japan