

**Portable Automatic Gas Cutter**



BHA00B22

# **MINIMANTIS II**

## **H-Shape Steel Cutter**

### **OPERATION MANUAL**



**For every person who will be engaged in operation and maintenance supervision, it is recommended to read through this manual before any operations, so as to permit optimum operation of this machine.**

**KOIKE SANZO KOGYO CO.,LTD.**

## **INTRODUCTION**

**Thank you very much for purchasing this product. Read this instruction manual thoroughly to ensure correct, safe and effective use of the machine. Read the manual first to understand how to operate and maintain the machine.**

**Cooperation between colleagues in the workplace is essential for safe, smooth operation. Make sure you read, understand and take all necessary safety precautions.**

## **SAFETY PRECAUTIONS**









**This product is designed to be safe, but it can cause serious accidents if not operated correctly. Those who operate and repair this machine must read this manual thoroughly before operating, inspecting and maintaining the machine. Keep the manual near the machine so that anyone operates the machine can refer to it as necessary.**

- Do not use the machine carelessly without following the instructions in the manual.
- Use the machine only after you have completely understood the contents of the manual.
- If an explanation in the manual is difficult to understand, contact our company or sales service office.
- Keep the manual to hand at all times and read it as many times as is necessary for a complete understanding.
- If the manual becomes lost or damaged, place an order with our company or sales service office for a new one.
- When transferring the machine to a new owner, be sure to hand over this instruction manual as well.

## **QUALIFICATIONS FOR MACHINE OPERATOR**

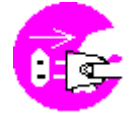
**Operators and repair staff of this machine must completely understand the contents of the instruction manual and have either of the following qualifications:**

1. Gas welding foremen's license
2. Completion of gas welding training course
3. Approval by the Minister of Labor

Symbol	Title	Meaning
	General	General caution, warning, and danger.
	Be careful not to get your fingers caught.	Possible injury to fingers if caught in the insertion port.
	Caution: Electric shock!	Possible electric shock under special conditions.
	Ground this equipment.	Operators must ground the equipment using the safety grounding terminal.
	Pull out the power plug from the outlet.	Operators must unplug the power plug from the outlet when a failure occurs or when there is a danger of lightning damage.
	Caution against bursting	Possible bursting under certain conditions.
	General	General warning.
	Caution: Hot!	Possible injury due to high temperature under certain conditions.
	Caution: Ignition!	Possible ignition under certain conditions.

# CONTENTS

1. Safety Information .....	1
1.1 General machine safety precautions .....	1
1.2 Gas cutting safety precautions .....	3
2. Locations of safety labels .....	5
3. Outline of machine .....	6
3.1 Features of machine .....	6
3.2 Name and function of each section .....	6
3.3 Specifications .....	7
4. Preparation for operation .....	8
4.1 Contents of package .....	8
4.2 Function of each section .....	8
4.3 Machine assembly .....	12
4.4 Preparation for operation .....	13
5. Cutting operation .....	14
5.1 Safety measures prior to operation .....	14
5.2 Ignition and flame adjustment .....	14
5.3 Cutting and piercing method .....	15
5.4 Safety measures against backfire and flashback .....	15
5.5 Cutting operation .....	16
5.6 Precautions in diagonal web cutting with an ST torch .....	20
6. Maintenance and inspection .....	21
6.1 Daily inspection .....	21
6.2 Periodical inspection .....	21
6.3 Maintenance and inspection of quick cock .....	21
7. Trouble shooting .....	22
8. Wiring diagram .....	26
9. Assembly drawing of MINIMANTIS II .....	26
10. Parts list .....	27
10.1 Body unit .....	27
10.2 Torch slide unit .....	29
10.3 Gas distributor operation plate unit .....	31
10.4 Rail Straight head type torch unit .....	33
11. Cutting Data .....	35

## **1 Safety information**

Many accidents are caused by operation, inspection, and maintenance which disregard the basic safety rules. Carefully read, understand, and master the safety measures and precautions described in this instruction manual and on the machine before operating, inspecting, and maintaining the machine.

The safety messages are classified as follows for machine safety labels:

### **■ WARNING**

This word is used in a warning message and a warning label at places that could cause injury or serious accident.

### **■ CAUTION**

This word is used in a caution message and a caution label at places that could cause slight injury or machine damage. This is also used as a caution for frequent dangerous actions.

### **■ NOTICE SIGNS**

This is a sign to show machine operators and maintenance engineers items that relate directly to damage of machines and surrounding facilities and equipment.

## **1.1 General machine safety precautions**

Read and fully understand the following important safety information:

### **1.1.1 Machine safety**

1. The machine casing is mainly made of aluminum alloy to reduce weight. For this reason, be careful not to drop a heavy item on the machine, or not drop the machine when carrying it since the alloy is not designed to withstand such impact.
2. When mounting hoses to the torch and distributor, tighten the nut with the attached wrench. After mounting, be sure to check there is no gas leak with a detection liquid. If a gas leak is found, retighten the nut firmly.
3. When fixing a tip to the torch, tighten the nut with the two wrenches attached. In addition, avoid damaging the taper of the tip since this may cause backfire.
4. Never disassemble the machine other than during maintenance and inspection. Otherwise, malfunction will result.
5. Never remodel the machine. Remodeling is very dangerous.
6. When changing the direction, make sure that the 4 direction switch is in the neutral (stop) position, and operate the direction switch after the machine has stopped.
7. Always turn the power off when not in use.
8. Never use the machine outdoors when the weather is wet. This will cause failure of the machine and could cause a fatal accident by electric shock.

### **1.1.2 Safety clothing**

1. Be sure to wear protectors (gauntlets, goggles, helmet, and safety shoes) during operation.
2. Avoid operating the machine with wet clothes or hands in order to prevent electric shock.

### 1.1.3 Operation and handling safety precautions

1. Read this instruction manual before operating the machine.
2. Mount and center the machine correctly and confirm correct motion before operation.
3. Before connecting the power plug to the outlet, make sure that the power switch is in the OFF position (or the normal/reverse changeover switch is in the stop position).
4. Prior to operating the machine, check the safety of the surroundings to avoid accidents.
5. Never move the machine while the preheat flame is on.
6. Take great care of spatters and dross when operating the machine at a high position. They may injure people below.
7. Keep the flange cutting rack bar and guide roller clean at all times. (For prevention of knocking)
8. Arrange the hose between the adjustor and distributor and that between the distributor and torch in a manner that they will not hinder the vertical movement of the rack bar.
9. Secure the cross-feed holder with the curved handle to prevent the holder from falling.
10. Mount the machine on the rail and then be sure to engage the clutch.
11. **The machine up/down unit is equipped with a down-limit shock prevention mechanism that makes the vertical pinion run idly when the torch collides.**   
(When collision occurs)
  - 1) Turn off the 4-way switch immediately to stop vertical drive.
  - 2) Gradually lower the up/down pipe from the approx. 100 mm lifted position, and release it at a location where it engages with the pinion.  
When the up/down pipe is released directly from the lifted position, the impact of the up/down pipe may break the roll pin.
12. Be sure to hold the handle when carrying the machine.

### 1.1.4 Electrical system precautions



1. Be sure to check the input power voltage of the machine before operation. The input power voltage should be in the range of  $\pm 10\%$  of the rated voltage. The machine should not be operated out of this range.
2. The metal plugs are screw-threaded, therefore, fully tighten them so that they will not come loose during operation.
3. Be sure to ground the cabtyre cable of the machine.
4. **Stop operation and turn off the power in the following cases, and ask a qualified electrician to repair the machine.** 
  - 1) Broken or abraded cables
  - 2) Water leakage from the machine or liquid damage to the machine
  - 3) Abnormal machine operation despite operating the machine according to the instruction manual
  - 4) Machine breakdown
  - 5) Poor machine performance that requires repair
5. Periodically inspect the electrical system.

### 1.1.5 Maintenance and inspection precautions



1. Ask a qualified electrician to perform repair and inspection service.
2. Disconnect the power plug before inspecting and repairing the machine.
3. Maintain the machine periodically.

## 1.2 Gas cutting safety precautions

Strictly observe the safety rules and precautions to ensure the safety of gas cutting operations. Operators and supervisors MUST keep safety in mind.

### 1.2.1 Prevention of explosion



1. Never cut pressurized cylinders or hermetically sealed containers.
2. Ensure sufficient ventilation for gas cutting to prevent the air from becoming stale.

### 1.2.2 Pressure regulator safety precautions



1. Before starting operation, check that all pressure regulators are operating correctly.
2. Ask a skilled repair engineer to perform maintenance and inspection service.
3. Do not use pressure regulators from which gas is leaking, nor malfunctioning pressure regulators.
4. Do not use pressure regulators smeared with oil or grease.

### 1.2.3 High-pressure gas cylinder safety precautions



1. Never use broken cylinders or cylinders from which gas is leaking.
2. Install cylinders upright and take measures to prevent them from falling.
3. Use cylinders only for specified purposes.
4. Do not smear container valves with oil or grease.
5. Install cylinders in a place free from heat, sparks, slag, and naked flame.
6. Contact the distributor if the container valves will not open.

Never use a hammer, wrench, or other tools to forcibly open container valves.

### 1.2.4 Safety precautions for hoses



1. Use the oxygen hose for oxygen gas only.
2. Replace cracked hoses or other hoses damaged by sparks, heat, unshielded fire, etc.
3. Install hoses without twisting.
4. To prevent breakage of hoses, take great care during operation and transportation.
5. Do not hold the hoses when moving the machine.
6. Periodically check the hoses for damage, leakage, fatigue, loose joints, etc. to ensure safety.
7. Cut hoses to the minimum possible length. Short hoses reduce hose damage and pressure drop, as well as reduce the flow resistance.

### 1.2.5 Safety precautions for fire



Take safety precautions to prevent fire prior to gas cutting.

Ignoring hot metal, sparks, and slag could cause a fire.

1. Keep a fire extinguisher, fire extinguishing sand, bucket full of water, etc. ready on the site where gas cutting is performed.
2. Keep flammables away from the cutting area to avoid exposure to sparks.
3. Always cool steel plates that have become hot after cutting, as well as hot cut parts or scrap, before bringing them close to flammables.
4. Never cut containers to which flammable materials are stuck.

### 1.2.6 Safety precautions for skin burns



Observe the safety precautions to prevent skin burns. Ignoring heat, spatter, and sparks during operation could cause a fire or burned skin.

1. Do not perform cutting near flammables. (Move flammables well away from the sparks.)
2. Do not cut containers filled with flammables.
3. Do not keep lighters, matches, and other flammables nearby.
4. Flames from the torch will burn skin. Keep your body away from the torch and tip, and check the safety before operating the switches and valves.
5. Wear the correct protectors to protect your eyes and body.
6. Correctly tighten the tip to prevent backfire.
  - When fixing a tip to the torch, tighten the nut with the two wrenches attached.
  - If the tip is tightened excessively, it will be heated during cutting and tightened still more, making it difficult to remove the tip.
  - Avoid damaging the taper of the tip since this may cause backfire.
7. Check with soapsuds for any leakage of gas from the connection part of the distributor, hose, and torch.

Never use oil or grease on the connection of the oxygen pipe to avoid backfire which may lead to explosion.
8. Be sure to check the following when igniting:
  - Place the torch on the torch holder before igniting.
  - Always wear the required protectors (gauntlets, goggles, helmet, etc.)
  - Check for any obstacles, dangerous materials, and flammables near or in the direction of cutting. Determine the gas pressure.
  - The gas pressure must be within the appropriate range. (For the gas pressure, refer to the Cutting Data.)
9. The torch, tip, and heat shield are heated to a very high temperature. Always wear gauntlets when handling them. Also, the surface after cutting is very hot so do not touch it even while wearing gauntlets.
10. Never move the machine while the preheat flame is on.



## 2 Locations of safety labels

Safety labels and other labels for correct operation are affixed to the machine.

Carefully read the labels and follow the instructions on them when operating the machine.

Never remove the labels. Keep them clean and legible at all times.

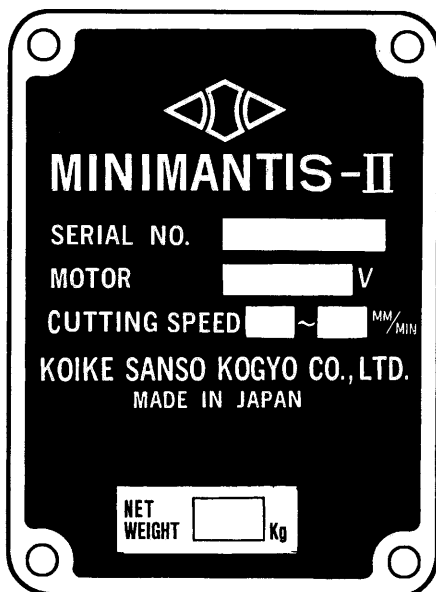
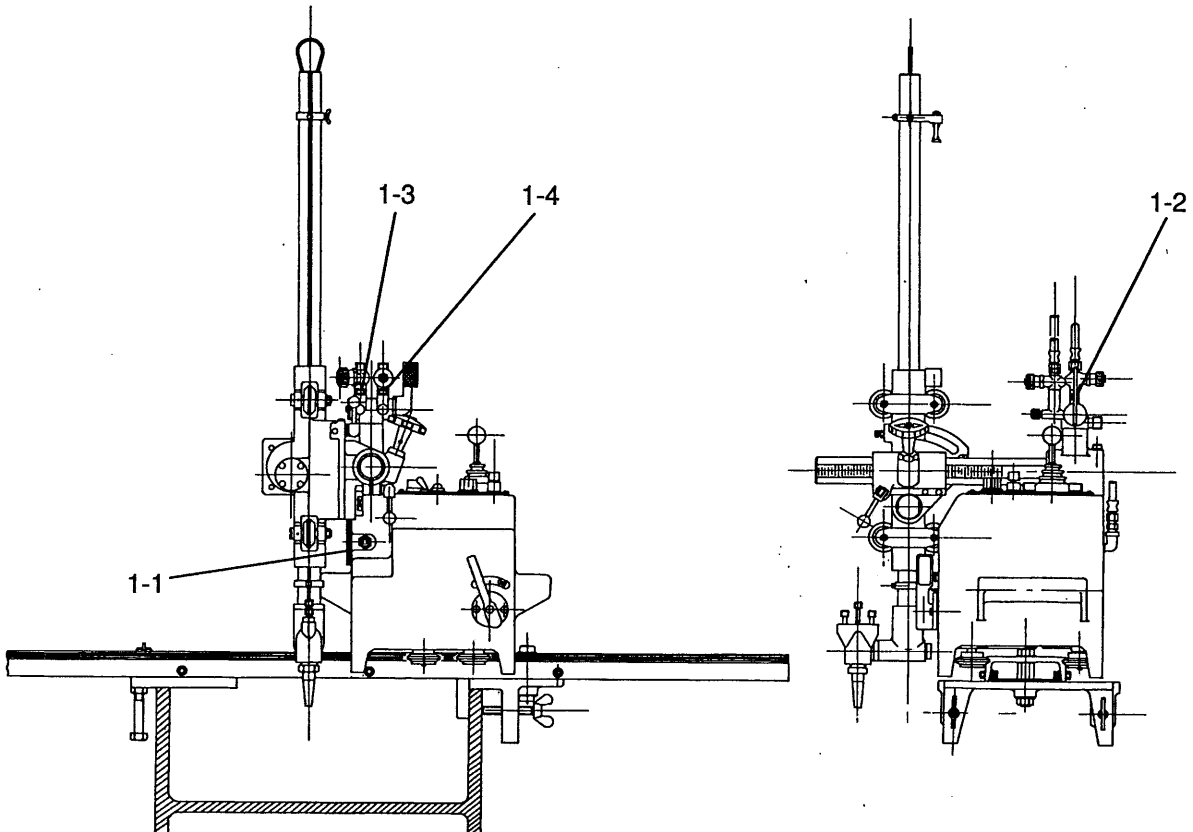

1-1



1-2



1-3



1-4

### 3 Outline of machine

#### 3.1 Features of machine

MINIMANTIS- II (H-Shaped Steel Cutter) is composed of a web cutter, flange cutter, operation panel, gas distributor, and rail with a clamp. It is made mainly of aluminum alloy for reduction of weight. Respective sections are connected to the web cutter, in which a motor, speed reducer, and clutch mechanism are incorporated. The web cutter runs on the rail by means of friction rollers. The flange cutter is attached to the side of the web cutter. The rack bar supported by four glide rollers moves vertically by means of the rack-and-pinion mechanism.

The operation of the machine is controlled through the operation panel on the web cutter.

#### 3.2 Name and function of each section

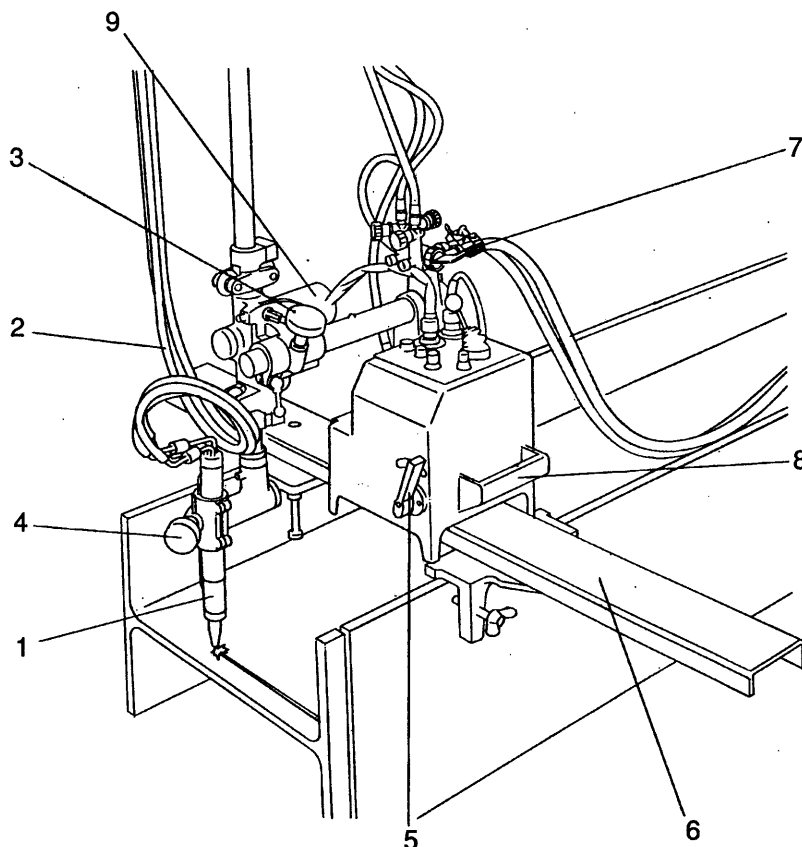

**1. Torch**

**2. Distribution hose**

Hose between the quick cock distributor and torch.

**3. Cross-feed handle**

Controls the horizontal movement of the torch.

**4. Up/down handle**

Controls the vertical movement of the torch.

**5. Clutch**

Move the clutch lever to the right to engage it (ON) and to the left to disengage it (OFF).

**6. Rail**

There are ST and LT rails.

**7. Quick cock distributor**

Just a single operation of the distributor permits flame adjustment for constant burning.

**8. Handle**

Use the handle when carrying the machine.

**9. Motor**

### 3.3 Specifications

Weight:	20Kg (incl. rail)
Body:	15Kg
Rail:	5Kg
Motor:	Web side DC motor (1/30 gear assembly) 15W Flange side DC motor (1/750 gear assembly) 15W
Power source:	±10%
Speed control:	Dial operation
Cutting speed:	100~700 mm/min (4"~27.5")
Drive:	Web side Function roller Flange side Rack and pinion
Cutting thickness:	5~30 mm (0.2"~1.18")
Tip:	102 (for acetylene) or 106 (for propane) # 0, 1, 2 one each
Gas:	Oxygen, acetylene gas, or LPG gas
Rail length (600 rail):	1100 mm (43.3")

#### ■Cutting dimensions and cutting method

- 1) Right-angle cutting  
A=150-600 mm (6"~24")  
B=150-400 mm (6"~16")
- 2) Diagonal web cutting  
35°at 400 mm (16") maximum diagonal web cutting  
35°maximum diagonal web cutting
- 3) Bevel cutting  
35°for both web and flange
- 4) Flange diagonal cutting  
30°at 300mm (12") maximum diagonal flange dimension  
30°maximum diagonal flange cutting

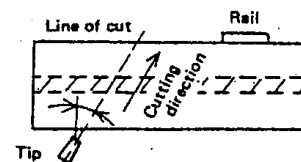
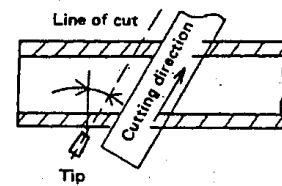
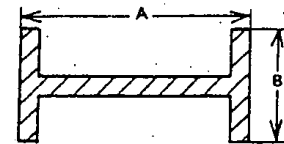

#### ●Standard accessories

TIP 102 (for acetylene) or 106 (for propane)	No. 0, 1, 2 1pc each
Power cable:	1 set
Tip cleaner:	1 set
Spanner (A, B, C):	1 set
Screw driver:	1 pc
Hose band:	1 set
Fuse (1A):	2 pcs
Center:	1 set

#### ●Torch up/down unit (Selective)

ST-400, ST-700

#### ●Rail (Selective)

600 rail, 900 rail, 1500 rail

## 4 Preparation for operation

### 4.1 Contents of package

The contents of the standard package are shown below. Check them carefully before assembling the machine.

- Body ..... 1 set
- Gas distributor (quick cock) ..... 1 set
- Torch holder ..... 1 set
- Torch ..... 1 pc
- Hose
  - Distributor hose (2 pcs set: 1900 L)..... 1 set
  - Distributor hose (1 pc: 400L)..... 1 set
- Power cable (3P×5M) ..... 1 pc
- TIP 102 (for acetylene) or 106 (for propane) ..... 1 pc each
- Tip cleaner ..... 1 set
- Screw driver ..... 1 pc
- Spanner (A,B,C)..... 1 set
- Fuse (1A) ..... 2 pcs
- Hose band..... 1 set
- Center ..... 1 set

### 4.2 Function of each section

#### 4.2.1 Quick cock (gas distributor)

Adjust the preheating flame and axially flame (pilot burner) once, and the lever operation ensures the same flame conditions at all times.

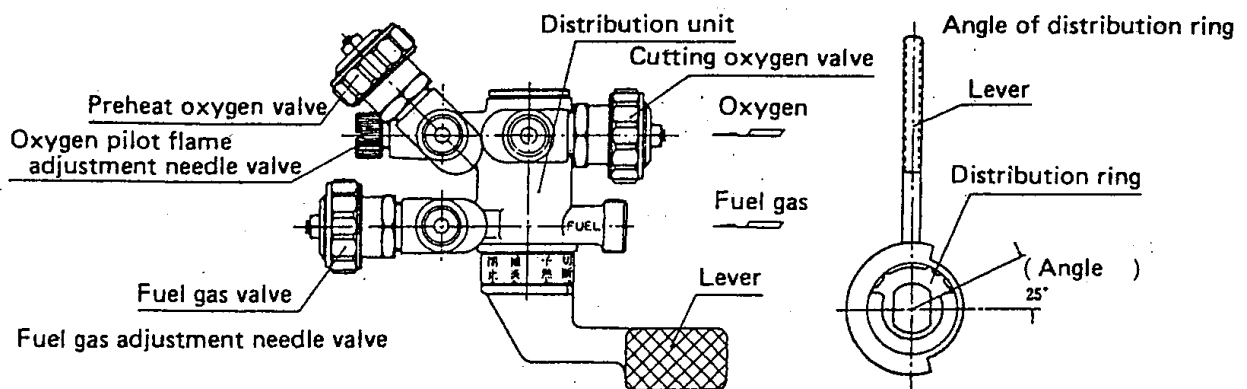

1.Positions of lever

Stop position : 1 set

Pilot Flame position : The gases flow, regulated by the valves.

Preheat position : Preheat flame comes on.

Cutting position : Preheat and cutting gas valves are fully opened to carry out cutting.

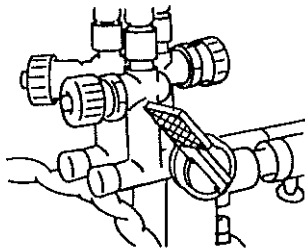

Stop position

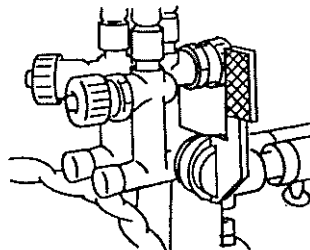

Pilot flame position

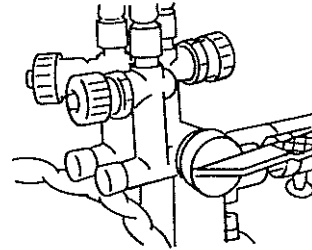

Cutting position

2.Adjustment of one torch flame adjuster

1).Turn the lever to Cutting to open the valves.

Ignite and adjust preheat flames. Get the best cutting oxygen flame by adjusting the valves.

2).Open the oxygen and fuel gas needle valves as shown in the figure below and bring the lever to the Pilot Flame position to adjust pilot flame.Adjust so that a lightly oxidized flame position to adjust pilot flame. Adjust so that a slightly oxidized flame is obtained.

When using oxygen and acetylene

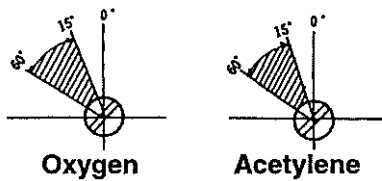

When using oxygen and LPG

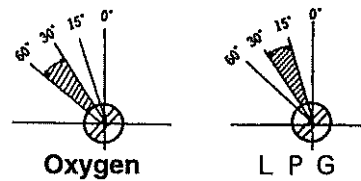

Angle adjustment of needle valves

After finishing the above adjustments, repeat the procedure from pilot flame to cutting (or preheating) a few times to check that flames are stable.

Adjusting as above enables identical flames to be obtained just by manipulating this lever.

For different pressures, adjust again from the beginning.

.2.2 4-way switch

This is a switch for driving the web running motor and flange running motor and is interlocked with the cutting oxygen.

○Arrows on the operation panel (When viewed from the clutch lever side)

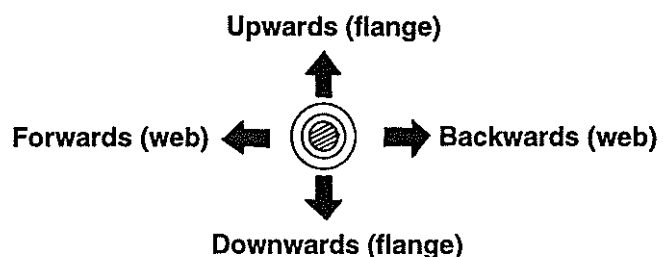
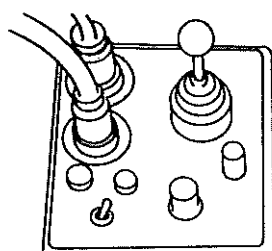

### 4.2.3 Quick-feed switch

When the push button is being pressed, both web and flange sides run at the maximum speed (approx. 700 mm/min). This function is convenient for quick-feeding and quick-returning during flange cutting. When the quick cock is in the cutting position, the cutting oxygen will not be supplied during operation.

### 4.2.4 Cross-feed mechanism

Used for aligning the tip center with marked lines, etc.

### 4.2.5 Flange angle control mechanism

Used for setting the angle during slantwise cutting of flanges.

### 4.2.6 Flange bevel angle control mechanism (For torch centering and adjustment as well)

The zero point is the centering position.

### 4.2.7 Speed control dial

Divided into 10 divisions for both web and flange cutting. The approximate relationship between the divisions and speed is shown below.

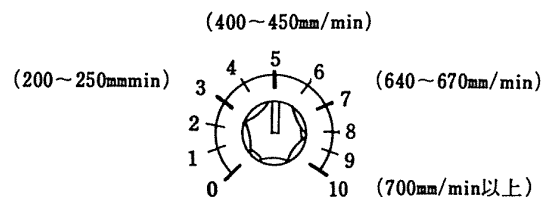

### 4.2.8 Clutch lever (for driving side roller as well)

The clutch lever is used mainly for automatic running during web cutting. It is also used for adjusting the tip distance and fixing the tip for flange cutting.

### 4.2.9 Up/down stopper for flange cutting

If the position is adjusted according to the flange height, driving and cutting oxygen supply will stop automatically when flange cutting is completed.

The upper limit stopper is fixed.

### 4.2.10 Rail

The rail is composed of a fixed base, movable base, and web angle control mechanism.

1. Fixed base ... Two locking bolts firmly clamp the flange section of H-shaped steel.
2. Movable base ... When the web dimensions change, the rail mounting position of the movable base is changed.
3. Web angle control mechanism ... For angled web cutting, loosen the angle fixing bolt and align the mark on the rail with the base graduation. Use the stopper for right-angle cutting.

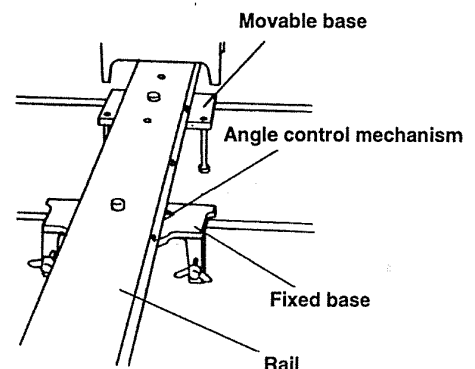

#### 4.2.7. Additional Explanation on Speed Control Dial (Cutting Speed Table)

The cutting speeds corresponding to the Graduations of the Speed Control Dial are approximately as follows. These figures are just for reference when the cutting speed is adjusted.

It shall be noted that, since the cutting speed of the web is different from that of the flange, they shall be adjusted in observing the actual cutting condition.

Graduation	Cutting Speed (mm/min)		
	Web	Flange Upward	Flange Downward
1	75	65	65
2	170	150	150
4	365	320	325
6	550	475	480
8	740	635	640
10	865	745	750

\* ) The speeds are approximate values.

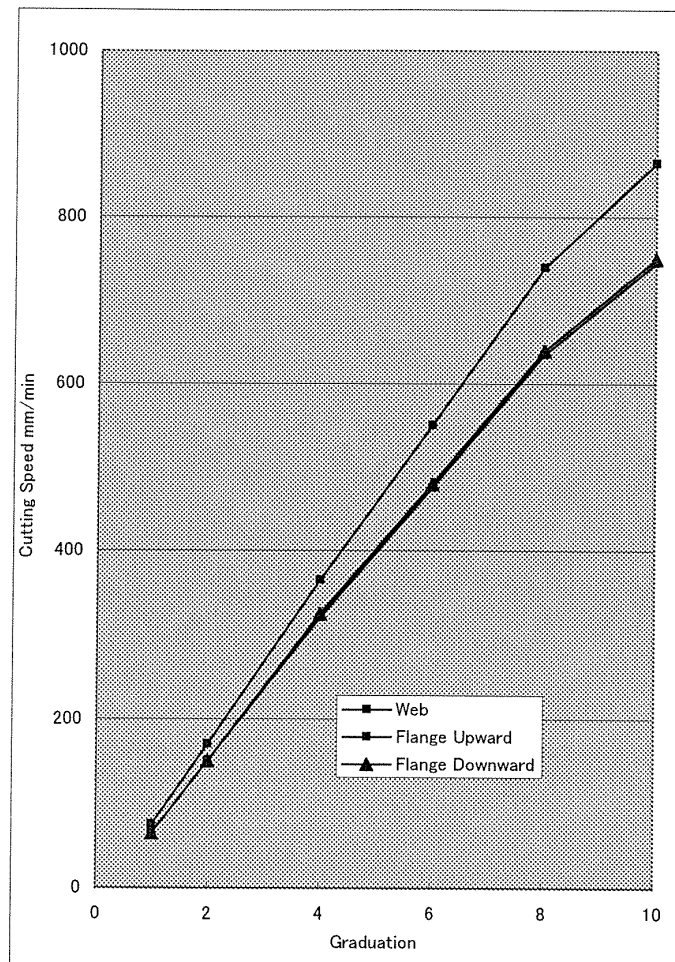

### 4.3 Machine assembly

1. MINIMANTIS is packed in three carton boxes. Open the respective boxes and take out the following parts.
  - MINIMANTIS-II machine assy .....1 pack
  - MINIMANTIS-II up/down unit.....1 pack
  - MINIMANTIS-II rail .....1 pack
2. Attach the flange cutter to the pipe arm. (Keep the torch horizontal at that time.) After moving the flange cutter to the center of the pipe, connect the metal plug of the cabtyre cord to the machine.

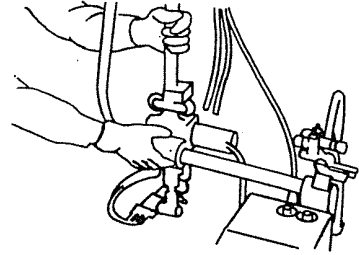

3. Attach the distribution hose to the quick cock (gas distributor). Connect the preheating oxygen hose to the pox valve and the inflammable gas hose to the gas valve. Attach the cutting oxygen hose to the outlet of the solenoid valve under the arm holder.

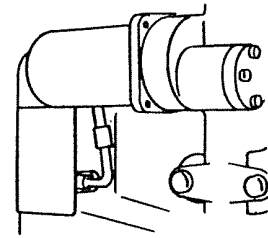
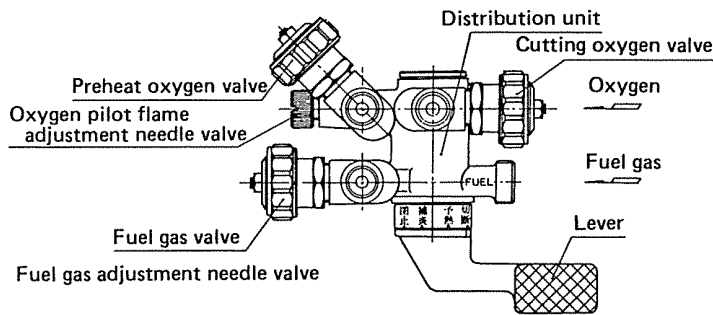



## 4.4 Preparation for operation



### 4.4.1 Connecting the power cable

1. Connect the power cable to the body.
2. Before plugging the metal plug on the cable side into the socket on the machine side, check there is no dust inside.
3. The metal plugs are screw-threaded, therefore, fully tighten them so that they will not come loose during operation.

### 4.4.2 Connecting the tip

1. Select a proper tip according to the thickness of the steel plate and attach it to the torch.  
(To select a tip, refer to the table of cutting data.)
  - When fixing a tip to the torch, tighten the nut with the two wrenches attached.
  - If the tip is tightened excessively, it will be heated during cutting and tightened still more, making it difficult to remove the tip.
  - In addition, avoid damaging the taper of the tip since this may cause backfire.

### 4.4.3 Mounting the machine

1. Set the movable base of the rail according to the H-shape web dimensions.

The relationship between the web dimensions and mounting positions is shown below.

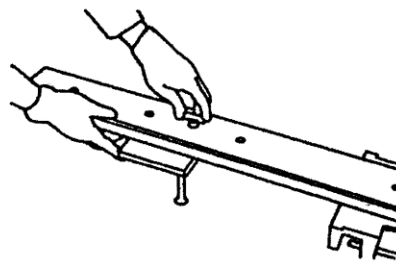

600 rail

Mounting position	Web dimensions (mm)
1	152~300
2	245~395
3	300~470
4	470~600

900 rail

Mounting position	Web dimensions (mm)
1	152~300
2	245~395
3	300~470
4	470~600
5	640~770
6	810~900

2. Set the H-shaped steel on the rail. Tighten the two locking bolts.
3. Mount the machine on the rail.

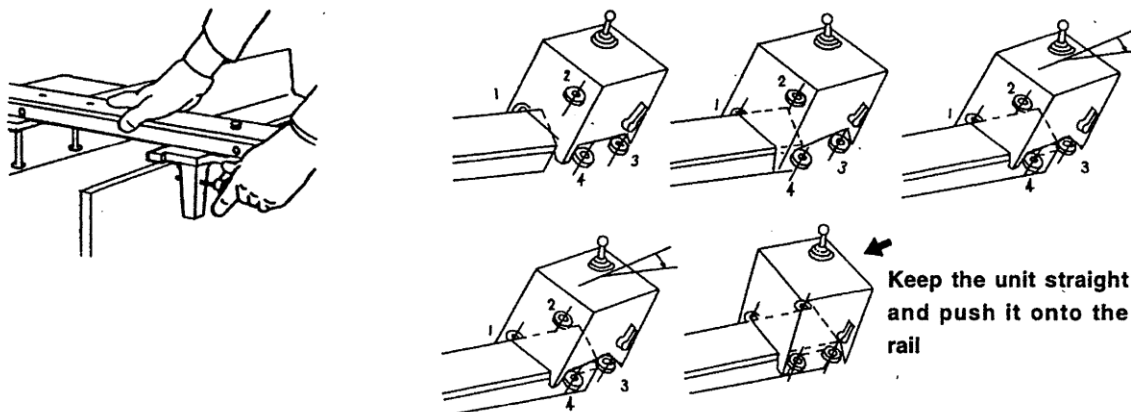

4. Insert the metal receptacle on the cabtyre cord (5 m) into the main unit and the plug on the opposite side into the power supply. Then turn on the power switch on the operation panel to light the pilot lamp.
5. After checking that the quick cock lever is in the “close” position, attach the primary-side hose and set the gas pressure at the specified value.

#### 4.4.4 Caution when using 1500 rail

The web dimension that can be mounted on the 1500rail is 900~1500mm.

When using the 1500 rail, the range that can be cut off of the flange differs from when using the 600 rail and 900 rail.

	ST-400	ST-700
600 rail	150~400	150~700
900 rail		
1500 rail	150~315	150~615

## 5 Cutting operation

### 5.1 Safety measures prior to operation

#### 5.1.1 Grounding the machine

The cable of this machine is equipped with a grounding wire. For safety, be sure to ground the wire as follows, in addition to checking the connection of the power cable.

##### ■ Method to ground the machine

- The ground pin is attached to the rubber plug of a cabtyre cord. Please use a power receptacle with a ground pin opening.

#### 5.1.2 Selection of tip

Referring to the Cutting Data, select the suitable tip according to the plate thickness.

For a heavily rusted plate or for a bevel cutting angle of more than 20°, select the tip one grade higher than the one shown in the Cutting Data.

#### 5.1.3 Operation of 4-way switch

- When changing the running direction, be sure to return the 4-way switch to the OFF (neutral) position. After the machine has stopped once, change the running direction.
- Be sure to set the switch in the OFF (neutral) position unless the machine is to be moved.
- Set the 4-way switch in the OFF (neutral) position when turning on the power. When the switch is in the forward or backward position, the machine will begin to move, which is very dangerous.
- Never put your hand between the magnet roller and the mold when the machine is traveling; otherwise your hand may be caught between them.

### 5.2 Ignition and flame adjustment

- Adjust the gas pressure according to the Cutting Data. The data shows the pressure when all the valves are open. Readjust the pressure after ignition.

##### ■ Flame adjustment method

1. Open the fuel gas valve 1/4 to 1/2 a turn, and light the torch with an igniter.
2. Then, open the preheating oxygen valve gradually until a white cone of the standard flame has been obtained. (The incandescent area should be uniform and about 5-6 mm (3/16-1/14") in length.)
3. Open the jet oxygen valve fully. Readjust the flame if its condition has changed. A disorderly flow of the jet oxygen will adversely affect the quality of the cutting surface. In such a case, clean the tip with a suitable cleaning needle while the jet oxygen is flowing.
4. Appropriate distance between the tip end and cutting surface:
  - Acetylene gas .....8-10 mm
  - LPG gas .....5-8 mm

Neutral flame ensures good quality cut surfaces. (Oxygen flame may be used for bevel cutting.) Oxygen flame causes short cutting-oxygen current, allowing slugs to adhere, melting the upper edge of the cutting surface, and causing other adverse effects on the cut surface. Similar defects will result when the cutting oxygen pressure is too high.

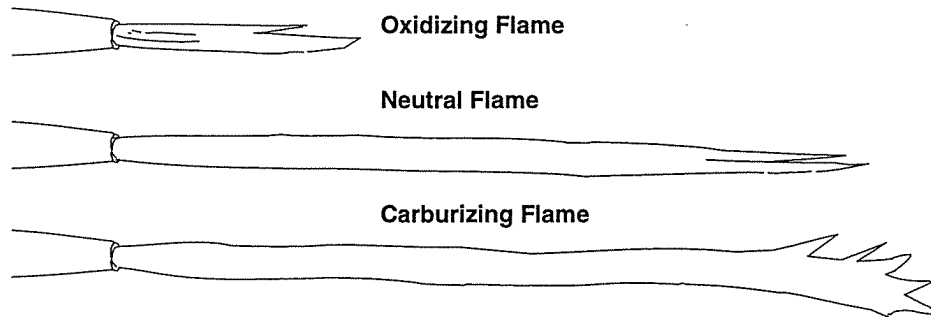

### 5.3 Cutting and piercing method

1. Cut in from the end of steel plate.
2. Pierce steel plate before cutting.
3. Drill a hole before cutting.

#### ■ Piercing method

- 1) Ignite and adjust the flame.
- 2) Thoroughly preheat the cut-in point until it is white hot.
- 3) Open the cutting oxygen valve to pierce the steel plate. The tip should be about 15-20 mm from the plate to prevent slag from splashing onto the tip and adhering there, which will shorten the working life of the tip.

### 5.4 Safety measures against backfire and flashback



#### 5.4.1 Prevention of backfire



Backfires may cause serious accidents or fires. Be careful to prevent such disaster. When a backfire occurs, find the cause and inspect and maintain the machine correctly before using the machine again.

The following are causes of backfire:

- 1) Improper gas pressure adjustment
- 2) Overheated tip
- 3) Slag clogged in tip
- 4) Damage to the tapered section of the tip or torch will cause backfire.

#### 5.4.2 Prevention of flashback



Flashback could cause fire and break the machine. Should there be a hissing sound in the torch, quickly take the following action:

- 1) Close the preheating oxygen valve.
- 2) Close the fuel gas valve.
- 3) Close the cutting oxygen valve.

Should flashback occur, find the cause and take appropriate action before using the machine again.

## 5.5 Cutting operation

1. Slightly raise the torch, operate the cross-feed handle, and align the center of the tip with the marked line on the end face.

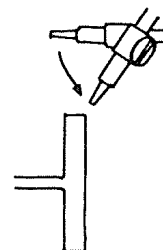

2. Set the distance between the web surface and tip. (LT type only) While the upper limit stopper of the flange is operating, place the torch upright on the web surface, and set the tip distance at 7-10 mm by means of the torch feed handle. Then turn the torch during web cutting, and the tip distance will be maintained constantly. After flange cutting, be sure to raise the torch up to the position where the upper stopper operates; otherwise the effect of the LT type will not be exhibited.

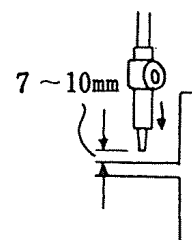

3. Disengage the clutch of the main unit, pull the machine along the rail to your side, place the torch horizontal, set the quick cock lever in the OFF position, and open the valve for ignition and adjustment of preheating flame.

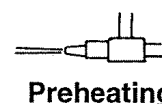

Then return the lever to the PILOT FLAME position for adjustment of the pilot flame. (For details, refer to the quick cock control procedure.)

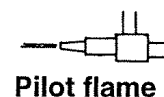

4. Set the 4-way switch in the downward position under the PILOT FLAME conditions, then keep pressing the quick-feed switch to lower the tip along the flange surface. Set the distance between the flange surface and tip at 7-10 mm at that time, and engage (ON) the clutch and fix it there.

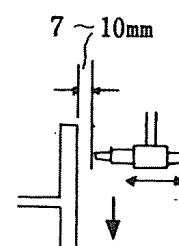

5. Return the switch to the stop position when the center of the tip has shifted approx. 5 mm from the flange edge, and fix the lower limit stopper at that location.

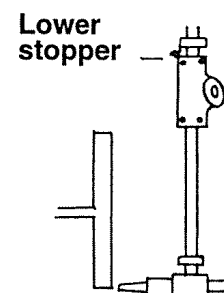

6. Set the speed.
7. Set the switch in the upward position and raise the tip until its center reaches the flange edge.

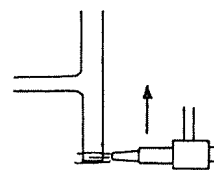

8. Set the quick cock lever in the cutting position. After sufficient preheating, set the 4-way switch in the upward position, and the torch moves upward and the cutting oxygen jets out simultaneously, starting automatic cutting.

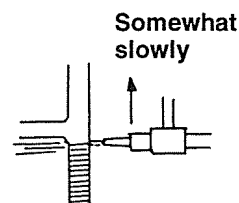

- After cutting began, finely adjust the speed depending on the condition of the flame. Gradually slow down the speed (1-1.5 divisions) before the torch reaches the center of the flange, and then resume cutting at the initial speed after passing the web surface. The web cutting depth of approx. 20 mm is ideal.

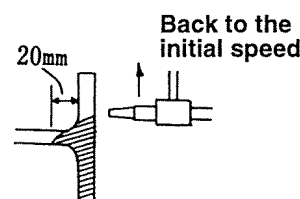

9. When the tip leaves the flange edge, return the quick cock to the PILOT FLAME position.

1) LT type

Keep pressing the quick-feed switch until the upper limit stopper is actuated.

2) ST type

Press the quick-feed switch. When the center of the tip moves to a position approx. 30 mm away from the flange edge, set the 4-way switch in the stop position.

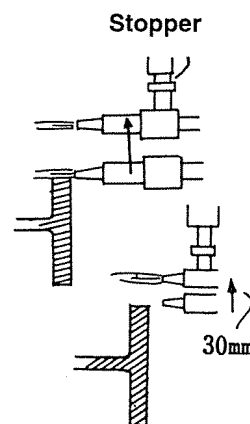

10. Quickly remove slugs from the web cutting surface by means of a hammer, etc.

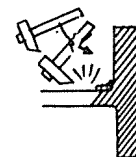

11. Disengage the clutch, and while pushing forward the machine on the rail, raise the torch upright by hand.

1) LT type

Raise the torch upright, and the tip height will be set automatically.

2) ST type

Set the 4-way switch in the downward position, and lower the tip until it will be 7-10 mm away from the web surface. It will be convenient to use the quick-feed switch simultaneously at that time. However, be careful not to let the tip strike against the web surface.

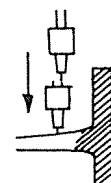
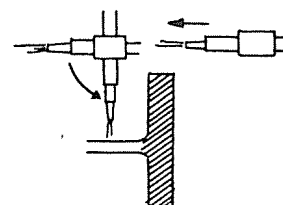

12. Bring the center of the tip to the web cutting edge, engage the clutch, and set the quick cock in the CUTTING position for preheating. Use slightly faster speed than flange cutting speed. (In general, webs are thinner than flanges.)

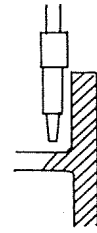

13. When the web surface becomes red hot, set the 4-way switch in the LEFT position to start automatic cutting.

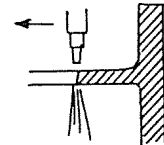

14. Set the switch in the stop position 2-3 mm before the torch touches the flange surface. After returning the quick cock to the PILOT FLAME position:

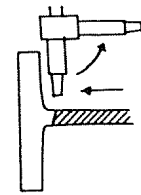

(LT type)

Quickly set the torch in the horizontal position.

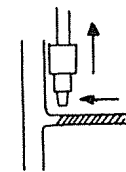

(ST type)

Set the 4-way switch in the UPWARD position, raise the torch while operating the quick-feed switch simultaneously, and set the torch in the horizontal position.

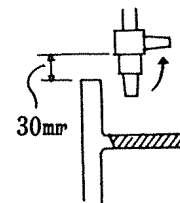

When the torch moves to a position approx. 30 mm away from the flange surface, set the switch in the stop position.

15. Disengage (OFF) the clutch, set the switch in the DOWNWARD position while pushing forward the machine on the rail, and lower the torch until the center of the tip reaches the flange edge while operating the quick-feed switch simultaneously.

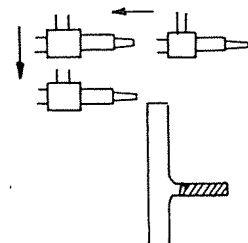

16. After setting the distance between the flange surface and the tip at 7-10 mm, engage the clutch and fix it there, and set the quick cock in the CUTTING position for preheating. (Return the speed to the flange cutting speed at that time.)

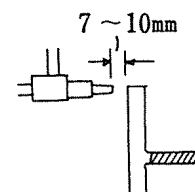

17. After preheating, set the switch in the DOWNWARD position, and the flange moves down and cutting begins.

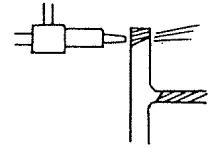

18. Gradually slow down the speed from the position just before the center of the flange, and after confirming the cut web surface, set the speed back to the initial speed.

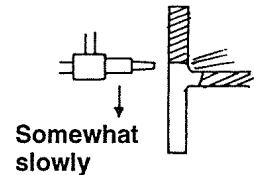

19. After cutting, the lower limit stopper stops driving and cutting oxygen supply simultaneously. Return the quick cock to the STP position.

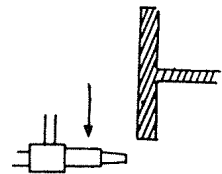

**The cut material falls at that moment. In order to prevent the cut material from hitting against the tip, disengage (OFF) the clutch and move the machine forward, or take other measures to protect the tip.**

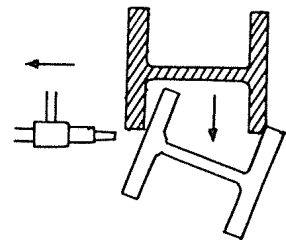

20. Set the switch in the UPWARD position, and keep pressing the quick-feed switch until the rising torch stops by the upper limit stopper.

21. Loosen the two locking bolts on the rail, and remove the rail and the machine.



**When placing the machine on the floor or carrying the machine, be sure to set the torch in the uppermost position. (For prevention of damage to the up/down unit, torch, and its related parts)**

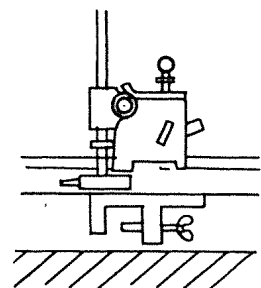



## 5.6 Precautions in diagonal web cutting with an ST torch

When doing diagonal web cutting with an ST torch, if you use the torch without any adjustment, there will be some uncut sections left. So adjust the torch following the procedure shown in Fig.1 and 2.

When resuming flange cutting, set the flange bevel graduation to zero.

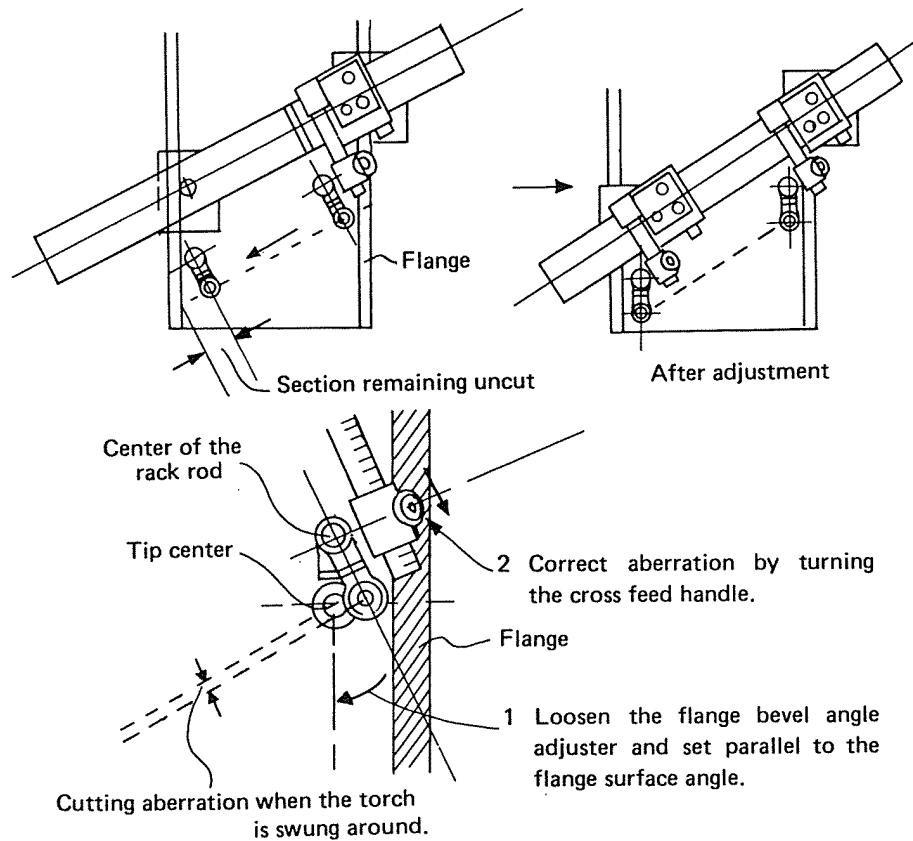

## **6 Maintenance and inspection**

Refer to the following points for maintaining and inspecting the machine in order to use the machine under the best conditions.

### **6.1 Daily inspection**

1. Wipe the outside of the machine with a clean cloth.
  - Up/down rack bar and rack bar supporting guide roller
  - Pipe arm and angle control section
  - Carriage drive roller and guide roller
  - Torch and torch holder
  - V-groove in the rail (Roller running surface)
  - Rail and clamp fixing section and angle control section
  - exercise special care when cleaning the above sections.
2. Check that rotary parts rotates correctly without excessive play.
3. Check that there is no gas leakage from joints.

### **6.2 Periodical inspection**

1. Remove dust from the electric equipment related parts inside the operation box.
2. Remove the flange cutting motor, and supply grease to the speed reducer.
3. Separate the web cutting speed reducer from the motor, and change grease or supply grease to the reducer box depending on its condition.
4. Oil the roller section.
5. Replace parts when they are abraded substantially.
6. Inspect the distributor as shown below.

### **6.3 Maintenance and inspection of quick cock**

1. Set the lever in the CLOSE, PILOT FLAME, PREHEATING, and CUTTING positions respectively every three months, and check for gas leakage with the help of soapy water.
  2. Distribution ring grease is used for the lever distribution ring. Supply grease every three to six months. (The distribution ring can be removed easily from the main unit by removing the mounting screw on the side opposite to the lever.)

Uniformly apply grease the circumference of the ring. Do not apply grease excessively. Be careful not to let dust enter.
  3. When the movement of the lever is extremely slow and when gas leakage is found in the distribution ring section, tighten the distribution ring mounting screw again. When the condition is still abnormal, replace the distribution ring with a new one.
- When gas leakage from the distribution ring is detected after use for an extended period of time or when the flame changes substantially during lever operation, replace the distribution ring with a new one. The service life of the distribution ring is said to be 10,000 times on average.

## 7 Troubleshooting

### 1. Web and flange cuts not in alignment

- 1) Flange bevel angle adjustment (ring) has not been set properly to zero.

Loosen the butterfly nut at the back, and adjust the scale so that the three marks line up with the corresponding marks.

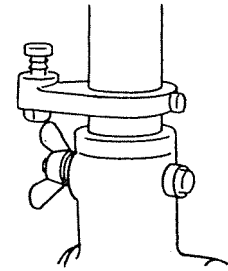

### ■ Method to check torch centering

- 1) After attaching the centering jig to the tip, set the torch horizontally so that it will be flush with the side of the rail. Apply a scale from the side of the rail and tilt the torch to right and left. If the dimensions of the center of the tip are the same at that time, the condition is good.

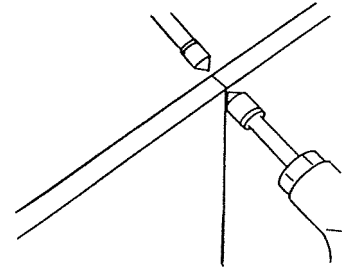

- 2) Mark a line in parallel with the rail on the top surface of the flange of the H-shaped steel to be cut, and lower the torch until it is about to touch the flange top. Tilt the torch to the right and left, and if the center of the tip is in the same position as the marked line, the condition is good. If they do not coincide, the flange bevel angle controlling scale may be incorrect. Correct it according to the procedure 1).

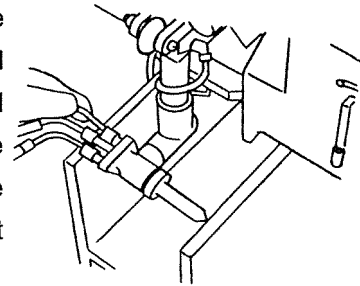

### 2. Abnormal cutting oxygen jet

- 1) The jet flows out at an angle



- 2) The jet is sprit.



- 3) The jet is too short. Jet length should be more the 80mm (3.2")

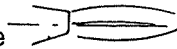

Clean the tip or readjust the cutting oxygen valve. If a normal jet still cannot be obtained, replace with a new tip.

■ Neither web nor flange cutting can be carried out. (Both web and flange motors do not go.)

Possible Cause	Procedure
1) Blown fuse	Check
2) Faulty power switch	Check with tester.
3) Faulty direction switch	Check with tester.
4) Faulty <i>controller</i>	Replace.
5) Faulty cabtyre cable	Check with tester.

■ Only one motor does not go.

Possible Cause	Possible Cause	Procedure
1) Neither right nor left travel can be carried out	1) Faulty motor	Check with tester.
	2) Faulty drive roller contact pressure	Adjust.
	3) Faulty clutch	Adjust.
2) No travel to the right.	1) Faulty direction switch	Check with tester.
	2) Faulty relay (RL3)	Replace.
3) No travel to the left.	1) Faulty direction switch	Check with tester.
	2) Faulty relay (RL4)	Replace.

■ Only flange cutting cannot be done.

Possible Cause	Possible Cause	Procedure
1) Neither up or down travel is possible.	1) Faulty motor	Check with tester.
	2) Faulty reduction gear	
2) No up travel.	1) Faulty direction switch	Check with tester.
	2) Faulty upper limit switch	Check with tester.
	3) Faulty up travel relay (RL1)	Replace.
3) No down travel	1) Faulty direction switch	Check with tester.
	2) Faulty lower limit switch	Check with tester.
	3) Faulty down travel relay (RL2)	Replace.

Reference: 1. When the relay seems to be defective, check the relay inserting conditions.

2. When checking the relay operation, remove the relay and directly supply to terminal numbers 13 and 14 to check the operation of the contact point.

Possible Cause	Possible Cause	Procedure
1) Abnormal travel speed	1) Faulty <i>controller</i>	Replace.
	2) Faulty control rheostat (50k $\Omega$ )	Replace.
2) Carriage runs but abnormally	1) Faulty rapid traverse switch	Check with tester.
	2) Other cause	Check with tester.

Note:

Protection of the over load.

When the motor was locked by any reason, the motor rotation will be stopped after about four second.

(Recovery: Please turn on the power supply again.)

■ Only flange cutting cannot be done.

Possible Cause	Possible Cause	Procedure
1) Knocking	1 Worn gears	Check with tester.
	Excessive guide roller play	Adjust
	Damaged or dirty rail or rack rod	Clean or replace
	Obstruction by hoses or cabtyre cables	Rearrange
	Damaged or dirty drive wheels or guide rollers	Clean or replace
2) Excessive vibration or noise	Worn reduction gears, or foreign matter in reduction gears	Clean or replace
	Faulty motor	Check and repair or replace
3) Cutting oxygen does not flow out, or stops	Faulty solenoid valve	Clean or replace

## 8 Wiring diagram

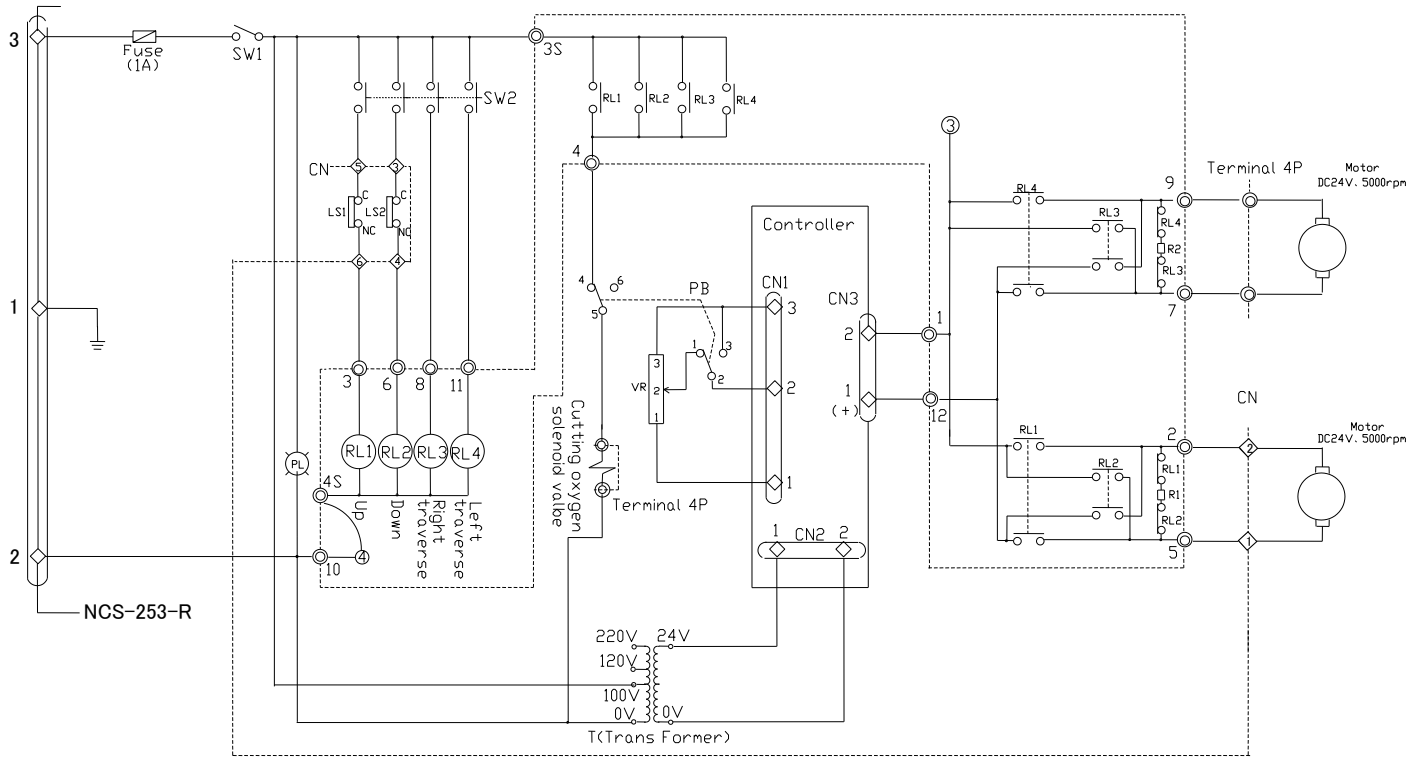

## 9 Assembly drawing of MINIMANTIS II

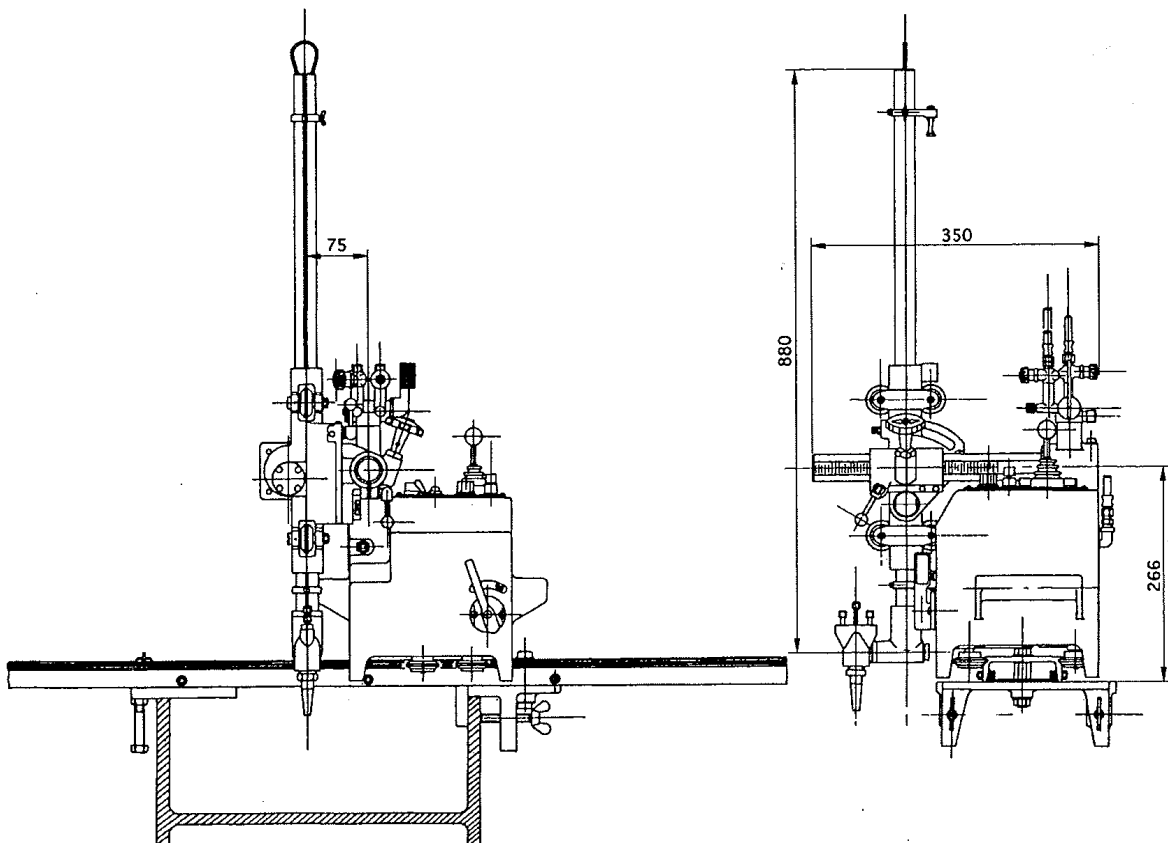

**10** Parts list

**10.1** Body unit

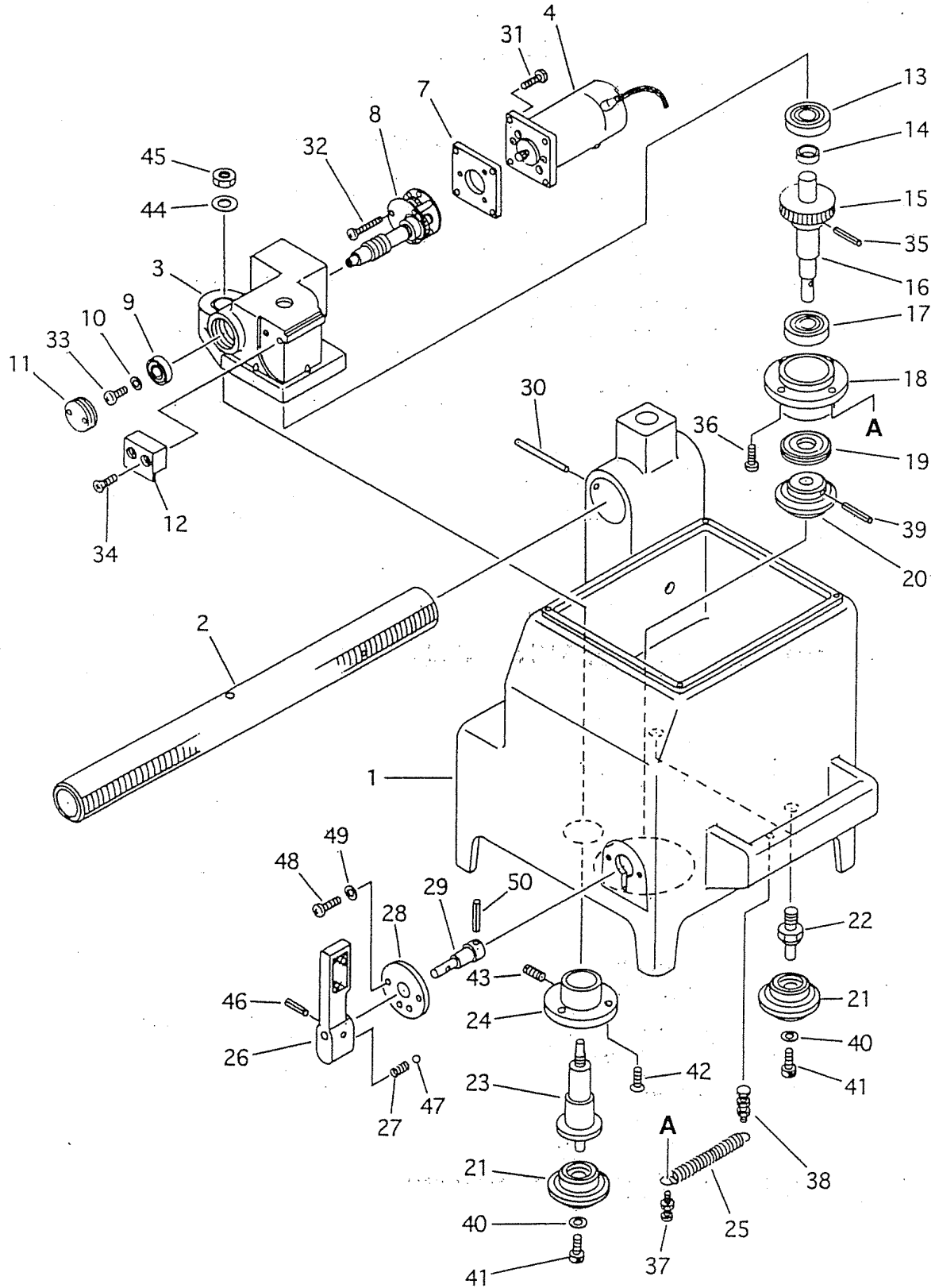



**Body unit**

ITEM No.	PART NAME	QTY	STOCK No.	REMARKS	ITEM No.	PART NAME	QTY	STOCK No.	REMARKS
1	Main unit case	1	60031238	With BC-6×10 2PCS	33	Screw	1	6C520406	SP-4×6
2	Pipe arm(A)	1	60031241		34	Screw	2	6C500520	SF-5×20
3	Gear box	1	60031270	With DU bush	35	Spring pin	1	6B024026	PR-4×26
4	Motor (DC24V)	1	61007886	15W 5000r.p.m With Pinion	36	Screw	3	6C520515	SP-5×15
7	Spacer	1	61000546		37	Screw	1	6C520525	With Nut SP-5×25
8	Gear assembly	1	61001648		38	Hexagon bolt	1	6C010525	With Nut 2PCS BH-5×25
9	Bearing	1	6A030627	627ZZ	39	Spring pin	1	6B024028	PR-4×28
10	Washer	1	60031015		40	Washer	3	6D500050	WF-5
11	Bearing retainer	1	60031014		41	Hex,socket head screw	3	6C030510	BC-5×10
12	Clutch lever plate	1	60031274		42	Screw	3	6C500515	SF-5×15 ★
13	Bearing	1	6A036001	6001ZZ	43	Screw	1	6C560515	SSS-5×15
14	Collar	1	60031273		44	Washer	1	6D500100	WF-10
15	Worm wheel	1	60031272		45	Nut	1	6D010100	NH-10
16	Drive wheel shaft	1	60031271		46	Spring pin	1	6B022016	PR-2×16
17	Bearing	1	6A036201	6201ZZ	47	Steel ball	1	60030480	TB-1/4"
18	Casing	1	60031278		48	Screw	2	6C520512	SP-5×12
19	Bearing retainer	1	60031311		49	Washer	2	6D500050	WF-5
20	Drive roller	1	60031276		50	Spring pin	1	6B024024	PR-4×24
21	Roller assembly	3	60031235	608ZZ With stop ring					
22	Guide roller shaft	2	60031284						
23	Gear box fitting shaft	1	60031281						
24	Casing	1	60031280						
25	Spring	1	60031287						
26	Clutch lever	1	60031234						
27	Lever spring	1	60031236						
28	Clutch shaft holder	1	60031282						
29	Clutch shaft	1	60031283						
30	Taper pin	1	6B044050	PT-4×50					
31	Screw	4	6C530418	With WS SP-4×18 ★					
32	Screw	3	6C520222	SP-2×22 ★					

10.2 Torch slide unit

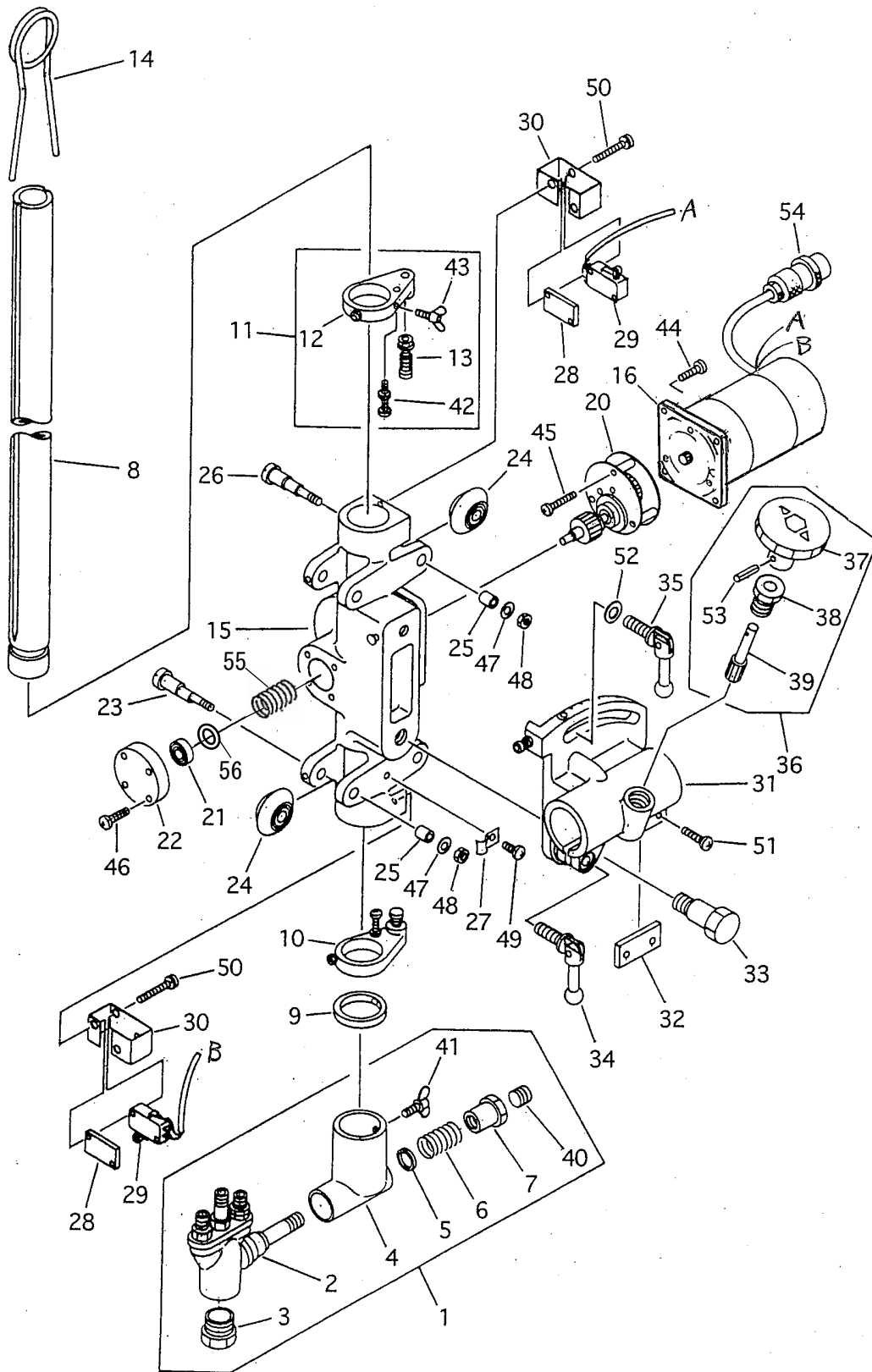

## Torch slide unit

ITEM No.	PART NAME	QTY	STOCK No.	REMARKS
1	Torch and holder assembly	1	60032047	Except USA,KE
	Torch and holder assembly	1	61007865	USA only
2	Torch	1	60010401	Except USA,KE
	Torch	1	60010402	USA only
3	Tip fixing nut	1	60005020	
4	Torch holder	1	60031212	
5	Collar	1	60031219	
6	Spring	1	60031221	
7	Lock nut	1	60031213	
8	Slide bar	1	60031220	ST400/LT400
	Slide bar	(1)	60032027	ST700/LT700
9	Angle gradation ring	1	60031222	With SS-3x5
10	Upper stopper assembly	1	60031215	
11	Lower stopper assembly	1	60032050	
12	Stopper	2	60031216	
13	Limit shaft	2	60031217	
14	Hose hanger	1	60031218	
15	Guide roller holder	1	60031207	With screw
16	Motor (DC24V)	1	61007885	15w 5000rp
20	Gear assembly	1	60031299	1/375
21	Bearing	1	6A030626	626ZZ
22	Bearing adjusting metal	1	60031211	
23	Guide roller shaft (A)	2	60031223	
24	Guide roller assembly	4	60031225	
25	Guide roller collar	4	60031226	
26	Guide roller shaft (B)	2	60031224	
27	Saddle	2	64000150	
28	Spacer	2	60031227	
29	Limit switch	2	60031268	
30	Switch cover	2	60031214	
31	Guide roller holder bracket	1	60031208	M5x16 With Nut
32	Key	1	60030954	
33	Rotary shaft	1	60031209	
34	Crank handle	1	60032211	M8x25
35	Crank handle	1	60030313	M8x20

ITEM No.	PART NAME	QTY	STOCK No.	REMARKS
36	Cross feed handle assembly	1	60030316	
37	φ 50 Handle	1	60030317	
38	Pinion metal	1	60030318	
39	Pinion	1	60030319	
40	Screw	1	6C541210	SS-12x10
41	Wing bolt	1	6C110615	BS-6x15 ★
42	Screw	2	6C610425	SP-4x25 With Nut
43	Wing bolt	1	6C110410	BS-4x10
44	Screw	4	6C530415	SP-4x15 With WS
45	Screw	3	6C520320	SP-3x20
46	Screw	4	6C520415	SP-4x15 ★
47	Washer	4	6D500050	WF-5
48	Nut	4	6D010050	NH-5
49	Screw	2	6C520406	SP-4x6 ★
50	Screw	4	6C520320	SP-3x20
51	Screw	2	6C520415	SP-4x15 ★
52	Washer	1	6D500080	WF-8
53	Spring pin	1	6B022516	PR-2.5x16
54	Metal plug	1	6N100052	6P
55	Spring	1	60030257	
56	Washer	1	6D500060	WF-6

10.3 GAS distributor operation plate unit

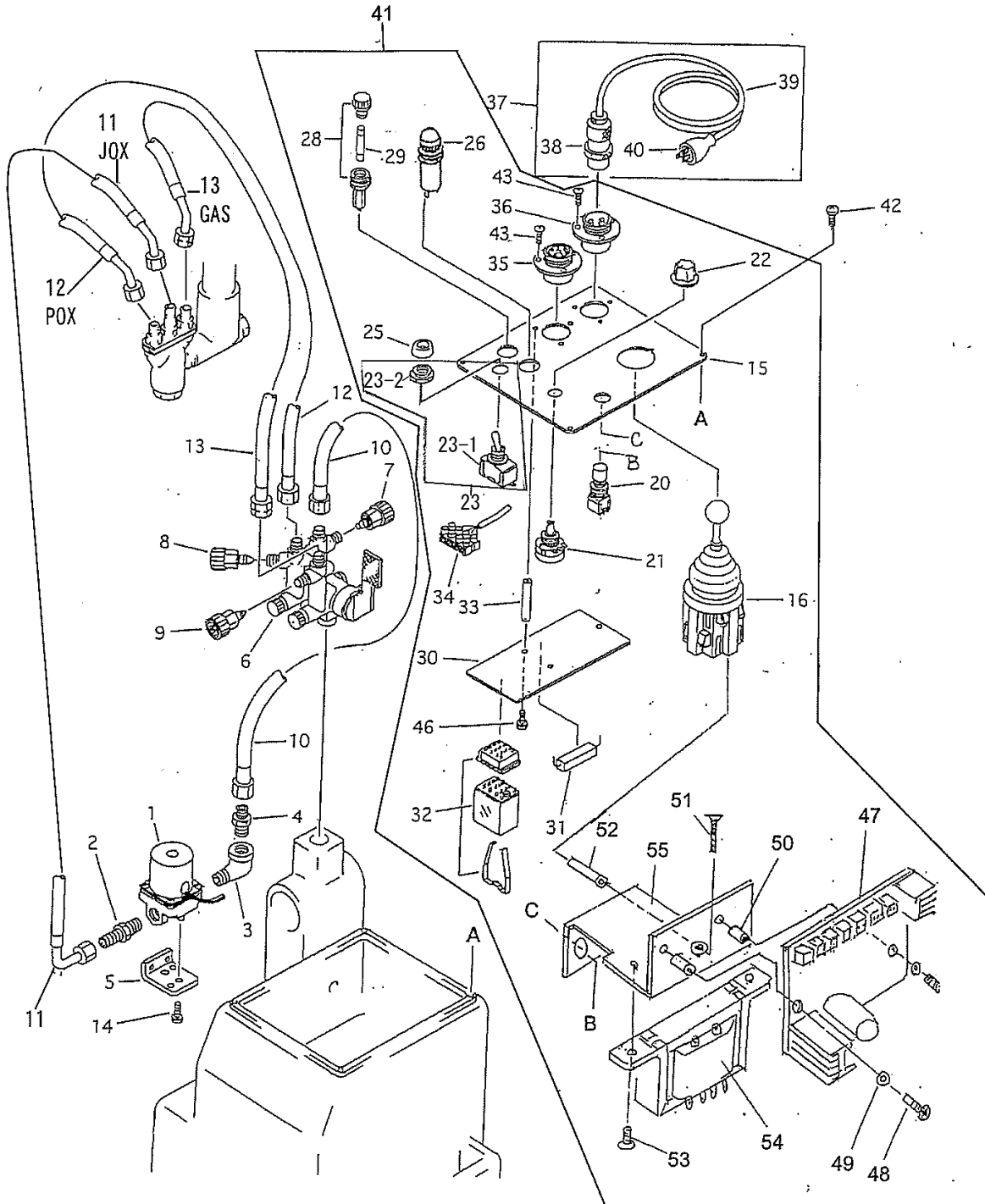

## Gas distributor operation plate unit

ITEM No.	PART NAME	QTY	STOCK No.	REMARKS
1	Solenoid valve(OX)	1	60032092	Except USA,KE
	Solenoid valve(OX)	1	60032093	120V USA,KE
2	Nipple	1	60031242	Except USA
	Nipple	1	60031243	USA only
3	Elbow	1	60032046	
4	Nipple	1	60032021	Except USA
	Nipple	1	60032022	USA only
5	Solenoid valve fitting plate	1	60032091	
6	Distributor	1	60010501	Except USA,KE
	Distributor	1	60010502	USA only
7	Valve for Jet oxygen	1	60015251	Except KE
8	Valve for Preheat oxygen	1	60015255	Except KE
9	Valve for Gas	1	60015256	
10	Hose for Jet oxygen	1	60030510	Except USA ST-400,LT-400
	Hose for Jet oxygen	1	60030509	USA only ST-400,LT-400
11	Hose for Jet oxygen	1	60032068	Except USA ST-400
	Hose for Jet oxygen	1	60031229	USA only ST-400
	Hose for Jet oxygen	1	60032069	Except USA ST-700
	Hose for Jet oxygen	1	60032023	USA only ST-700
12	Hose for Preheat oxygen	1	60031230	Except USA ST-400
	Hose for Preheat oxygen	1	60031231	USA only ST-400
	Hose for Preheat oxygen	1	60032030	Except USA ST-700
	Hose for Preheat oxygen	1	60032024	USA only ST-700
13	Hose for Gas (Red)	1	60031232	Except USA ST-400
	Hose for Gas	1	60031233	USA only ST-400
	Hose for Gas (Orange)	(1)	61001819	ST-400
	Hose for Gas (Red)	1	60032031	Except USA ST-700
	Hose for Gas	1	60032025	USA only ST-700
	Hose for Gas (Orange)	(1)	61001820	ST-700
14	Screw	2	6C530510	M5×10 With WS ★
15	Operation panel	1	60031240	
16	4-Direction switch	1	60031244	
20	Push button switch	1	60031248	
21	Variable resistor	1	60030745	
22	Handle	1	60031249	With Screw
23	Switch ass'y	1	61006769	
23-1	Switch	1	61006768	S-1A
23-2	Nut for dust protector	1	60032480	S-1A only

ITEM No.	PART NAME	QTY	STOCK No.	REMARKS
25	Cap for dust protector	1	60032431	
26	Neon lamp	1	6N380009	AC100V-AC120V
28	Fuse holder	1	60031286	
29	Fuse	1	60030707	1A
30	Printed card	1	60031289	
31	Resistor	2	60031247	
32	Relay	4	60031252	Except USA,KE
	Relay	4	60032044	USA,KE
33	Printed card fitting bar	3	60032071	
34	Terminal	1	60030656	4P
35	Metal socket	1	6N100054	6P
36	Metal socket	1	6N100061	3P
37	Cabtyre cord ass'y(3P)	1	61004264	
	Cabtyre cord ass'y(3P)	1	61004306	For transformers
38	Metal plug	1	6N100056	3P
39	Cabtyre cord(5M)	1	61004458	
40	Rubber plug	1	60030280	
41	Operation panel ass'y	1	61004410	Except KE,USA For 100V
	Operation panel ass'y	1	61004414	KE,USA For 120V
42	screw	4	6C520310	SP-3×10 ★
43	screw	6	6C510408	SM-4×8
46	Screw	2	6C520306	SP-3×6
47	Controller	1	69000105	
48	Screw	2	6C520310	SP-3×10
49	Isolation washer	2	60036374	WP-1
50	Spacer	2	6R020001	EP-5
51	Screw	1	6C500318	SF-3×18
52	Spacer	1	64000042	EM-14
53	Screw	2	20548792-Y	SP-3X5 with WS WF ★
54	Transformer	1	61000472	For 100,120V
55	Bracket	1	61001042	
55	Bracket	1	61001042	

10.4 Rail unit

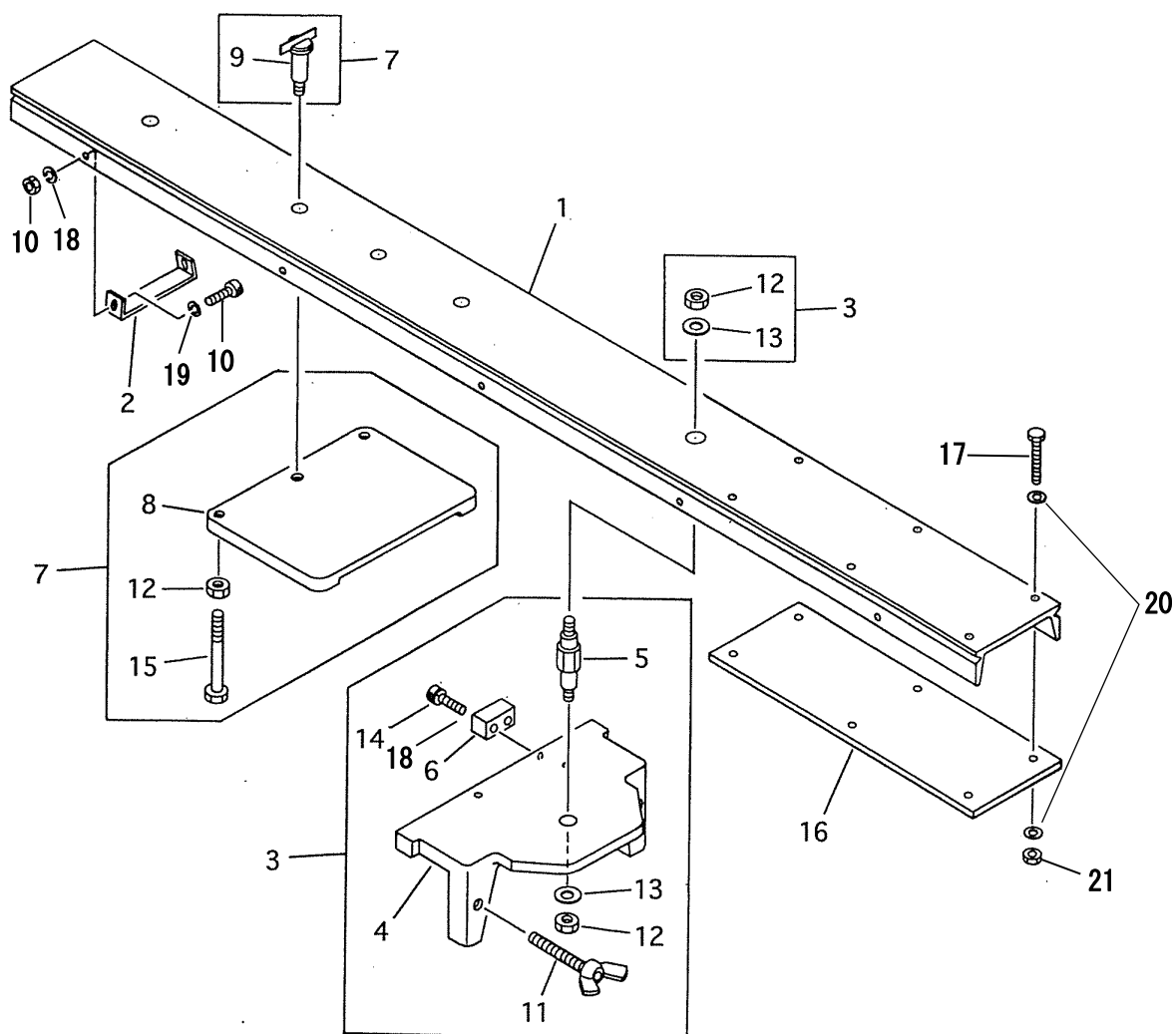

## Rail unit

ITEM No.	PART NAME	QTY	STOCK No.	REMARKS
1	Rail (ST TYPE)	1	60031262	For 600 mm
	Rail (ST TYPE)	1	60031263	For 900 mm
	Rail (LT TYPE)	1	60033094	For 600 mm
	Rail (LT TYPE)	1	60033095	For 900 mm
2	Set plate spacer	5	60031259	For 600 mm
	Set plate spacer	6	60031259	For 900 mm
3	Set base assembly	1	60032048	
4	Set base	1	60031257	
5	Set shaft	1	60031258	
6	Base plate	1	60031260	
7	Slide base assembly	1	60032049	
8	Slide base	1	60031261	
9	Fixing bolt	1	60031264	
10	Hex socket head screw	10	6C030515	BC-5×15 For WF,WS,NH
	Hex socket head screw	12	6C030515	BC-5×15 For WF,WS,NH
11	Wing bolt	2	6C121065	BS-10×65 ★
12	Nut	4	6D010100	NH-10
13	Washer	2	6D500100	WF-10
14	Hex socket head screw	2	6C030525	With WS
15	Hexagon bolt	2	6C011075	
16	Stabilizer	1	60033093	LT Type
17	Hexagon bolt (LT TYPE)	6	6C010645	With WS,NH
18	Washer	12	6D510050	WS-5(600mm) ★
	Washer	14	6D510050	WS-5(900mm) ★
19	Washer	10	6D500050	WF-5(600mm) ★
	Washer	12	6D500050	WF-5(900mm) ★
20	Washer	12	6D500060	WF-6 ★
21	Hexagon nut	6	6D010060	NH-6 ★

ITEM No.	PART NAME	QTY	STOCK No.	REMARKS

## 11 Cutting data

### 102(STANDARD SPEED) For Acetylene

PLATE THICKNESS (mm)	TIP SIZE	CUTTING SPEED (mm/min)	OXYGEN PRESSURE (kg/c m <sup>2</sup> ) / (Mpa)		FUEL GAS PRESSURE (kg/c m <sup>2</sup> ) / (Mpa)	KERF WIDTH (mm)
			CUTTING	PREHEAT		
3	00	680	1.5 / 0.15	1.5 / 0.15	0.2 / 0.02	1.0
6	0	610	2.0 / 0.2	2.0 / 0.2	0.2 / 0.02	1.3
10	0	560	2.0 / 0.2	2.0 / 0.2	0.2 / 0.02	1.5
12.5	1	530	2.5 / 0.25	2.5 / 0.25	0.2 / 0.02	1.8
19	2	460	3.0 / 0.3	3.0 / 0.3	0.25 / 0.025	2.0
25	2	430	3.0 / 0.3	3.0 / 0.3	0.25 / 0.025	2.0
38	3	355	3.0 / 0.3	3.0 / 0.3	0.25 / 0.025	2.3
50	4	320	3.0 / 0.3	3.0 / 0.3	0.25 / 0.025	2.8

### 102-D7(HIGH SPEED) For Acetylene

PLATE THICKNESS (mm)	TIP SIZE	CUTTING SPEED (mm/min)	OXYGEN PRESSURE (kg/c m <sup>2</sup> ) / (Mpa)		FUEL GAS PRESSURE (kg/c m <sup>2</sup> ) / (Mpa)	KERF WIDTH (mm)
			CUTTING	PREHEAT		
3	00	800	7.0 / 0.7	1.5 / 0.15	0.2 / 0.02	0.8
6	0	740	7.0 / 0.7	2.0 / 0.2	0.2 / 0.02	1.0
10	0	680	7.0 / 0.7	2.0 / 0.2	0.2 / 0.02	1.3
12.5	1	630	7.0 / 0.7	2.5 / 0.25	0.2 / 0.02	1.3
19	2	560	7.0 / 0.7	3.0 / 0.3	0.25 / 0.025	1.5
25	2	510	7.0 / 0.7	3.0 / 0.3	0.25 / 0.025	1.8
38	3	460	7.0 / 0.7	3.0 / 0.3	0.25 / 0.025	2.0
50	4	410	7.0 / 0.7	3.0 / 0.3	0.25 / 0.025	2.6

#### NOTE

- 1) All pressures are torch inlet pressures.
- 2) Oxygen purity is minimum of 99.7%.
- 3) Depending on the surface condition of the steel plate (scale, paint) either increase the fuel gas pressure or decrease the cutting speed. Also, when precision cutting is required, adjust all data.



**106(STANDARD SPEED) For Propane**

PLATE THICKNESS (mm)	TIP SIZE	CUTTING SPEED (mm/min)	OXYGEN PRESSURE (kg/c m <sup>2</sup> ) / (Mpa)		FUEL GAS PRESSURE (kg/c m <sup>2</sup> ) / (Mpa)	KERF WIDTH (mm)
			CUTTING	PREHEAT		
3	00	680	1.5 / 0.15	1.5 / 0.15	0.2 / 0.02	1.0
6	0	610	2.0 / 0.2	2.0 / 0.2	0.2 / 0.02	1.3
10	0	560	2.0 / 0.2	2.0 / 0.2	0.2 / 0.02	1.5
12.5	1	530	2.5 / 0.25	2.5 / 0.25	0.2 / 0.02	1.8
19	2	460	3.0 / 0.3	3.0 / 0.3	0.2 / 0.02	2.0
25	2	430	3.0 / 0.3	3.0 / 0.3	0.2 / 0.02	2.0
38	3	355	3.0 / 0.3	3.0 / 0.3	0.2 / 0.02	2.3
50	4	320	3.0 / 0.3	3.0 / 0.3	0.25 / 0.025	2.8

**106-D7(HIGH SPEED) For Propane**

PLATE THICKNESS (mm)	TIP SIZE	CUTTING SPEED (mm/min)	OXYGEN PRESSURE (kg/c m <sup>2</sup> ) / (Mpa)		FUEL GAS PRESSURE (kg/c m <sup>2</sup> ) / (Mpa)	KERF WIDTH (mm)
			CUTTING	PREHEAT		
3	00	800	7.0 / 0.7	1.5 / 0.15	0.2 / 0.02	0.8
6	0	740	7.0 / 0.7	2.0 / 0.2	0.2 / 0.02	1.0
10	0	680	7.0 / 0.7	2.0 / 0.2	0.2 / 0.02	1.3
12.5	1	630	7.0 / 0.7	2.5 / 0.25	0.2 / 0.02	1.3
19	2	560	7.0 / 0.7	3.0 / 0.3	0.2 / 0.02	1.5
25	2	510	7.0 / 0.7	3.0 / 0.3	0.2 / 0.02	1.8
38	3	460	7.0 / 0.7	3.0 / 0.3	0.2 / 0.02	2.0
50	4	410	7.0 / 0.7	3.0 / 0.3	0.2 / 0.02	2.6

## NOTE

- 1) All pressures are torch inlet pressures.
- 2) Oxygen purity is minimum of 99.7%, propane is minimum of JIS Grade 3.
- 3) Depending on the surface condition of the steel plate (scale, paint) either increase the fuel gas pressure or decrease the cutting speed. Also, when precision cutting is required, adjust all data.



---

<MEMO>

**MINIMANTIS II**  
**(H-Shape Steel Cutter)**  
**OPERATION MANUAL**

---

Date of issue	Feb.1996
2nd	Dec.2004
3rd	Jan.2007
4th	May.2007
5th	Nov.2008
6th	Dec.2008
7th	Apr.2009
8th	Jan.2010
9th	May.2010
10th	Jun.2010
11th	Jul.2010
12th	Dec.2010
13th	Oct.2011
14th	Nov.2011
15th	Feb.2012
16th	Jan.2013
17th	Feb.2013
18th	Mar.2013
19th	Sep.2014
20th	Dec.2014
21th	Apr.2015
22th	Nov.2017
23th	Apr.2018
24th	Dec.2023

---

**KOIKE SANZO KOGYO CO., LTD.**

Printed in Japan